



Group 8 - Compact Track Loaders and Attachments

<b><u>BOBCAT COMPANY SUGGESTED PRICE LIST - 01-01-2018</u></b>		
 <h1 style="display: inline-block; margin-left: 20px;">Bobcat Company</h1>		
<b><u>ORDER ADDRESS:</u></b> CLARK EQUIPMENT COMPANY dba BOBCAT COMPANY 250 EAST BEATON DRIVE PO BOX 6000 WEST FARGO, ND 58078-6000		
<b><u>Government Sales Points of Contact:</u></b>		<b><u>Phone:</u></b>
Heather Messmer - Government Accounts Sales Support Mgr. <a href="mailto:heather.messmer@doosan.com">heather.messmer@doosan.com</a>		(701) 241-8719
Jesse Rheault - Government Contracts Manager <a href="mailto:jesse.rheault@doosan.com">jesse.rheault@doosan.com</a>		(701) 241-8759
Randy Fuss - Director, Government Accounts <a href="mailto:randy.fuss@doosan.com">randy.fuss@doosan.com</a>		(701) 241-8746
TOLL FREE #: 800-965-4232, Opt#2 FAX#: 701-280-7860		
PROMPT PAYMENT TERMS: Net 30 TIME OF DELIVERY: 60 to 90 Days ARO COMMERCIAL CREDIT CARD: Accepted (Visa/Mastercard/American Express)		
TID#: 38-0425350		
<b><u>REMIT TO ADDRESS:</u></b> CLARK EQUIPMENT COMPANY dba BOBCAT COMPANY 75 REMITTANCE DR, SUITE 1130 CHICAGO, IL 60675-1130		
Product	 Bobcat	Discount Percent
SSL (Skid Steer Loader) - Group 11		30.0%
CTL (Compact Track Loader) - Group 8		30.0%
AWS (All Wheel Steer Loader) - Group 8		30.0%
Loader Attachments - Group 8 and 11		24.0%
MX (Mini or Compact Excavators) - Group 1		30.0%
MX Attachments - Group 1		24.0%

2-1-15 - Updated 3600/3650 PNs-prices

3-1-15 - updated some additions

3-5-15 - 8811 deleted

3-10-15 - removal of certain backhoes from Ldr Attach list

3-29-15 - Added S740 and Tier 4 machine pricing chged

4-28-15 - E26 - PN and some opt price changes and opt additions

2018 - Jan 2018 Pricing, Discontinued Products Removed, including obsolete versahandlers



Part Number	Compact Track Loader Description	SLP in US\$	Discount Percent	Price
-------------	----------------------------------	-------------	------------------	-------

M0207	<b>T450 Compact Track Loader (equipped with Tier 4 Engine)</b>	\$46,265.23	30.0%	\$32,385.66
-------	--	-------------	-------	-------------



Part Number	Air Conditioned/Heated Cab Packages Description	SLP in US\$	Discount Percent	Price
-------------	---	-------------	------------------	-------

M__-P01-A81	<b>A81 Option Package</b>	\$7,900.19	30.0%	\$5,530.13
-------------	---------------------------	------------	-------	------------

**A81**  
Enclosed Cab with AC/Heat  
Two Speed  
Cab Accessories Package\*  
Power Bob-Tach  
Sound Reduction  
Deluxe Instrument Panel with Keyless Start  
Attachment Control Kit  
3-Point Seat Belt

Part Number	Open Cab Packages Description	SLP in US\$	Discount Percent	Price
-------------	-------------------------------	-------------	------------------	-------

M__-P01-O71	<b>O71 Option Package</b>	\$2,106.79	30.0%	\$1,474.75
-------------	---------------------------	------------	-------	------------

**O71**  
Cab Accessories Package\*  
Power Bob-Tach  
Deluxe Instrument Panel with Keyless Start  
Attachment Control Kit

*\*Cab Accessories Pkg Incls: Deluxe Headliner with Dome Light, Cab Accessory Harness, Power Port, Lower Interior Panels with Storage Compartments, and Cup Holder.*

Part Number	Factory Installed Options Description	SLP in US\$	Discount Percent	Price
-------------	---------------------------------------	-------------	------------------	-------

M__-R01-C03	<b>Advanced Control System (ACS)*</b> Allows operator to select either hand or foot control of lift and tilt functions.	\$1,436.31	30.0%	\$1,005.41
-------------	--	------------	-------	------------

M__-R01-C04	<b>Selectable Joystick Control (SJC)*</b> Standard features include: Selectable patterns (ISO or H-Pattern), Horsepower Management, Speed Management, Drive Response and Foot Pedal for Engine Speed Control.	\$2,619.39	30.0%	\$1,833.57
-------------	--	------------	-------	------------

M__-R80-C02	<b>*IF a Cab Option Pkg is not ordered, a Cab Accessories Pkg must be ordered with ACS or SJC</b>	\$425.46	30.0%	\$297.82
-------------	---	----------	-------	----------

M__-R04-C02	<b>Two Speed</b> Incls 2-speed motor and 3-point seat belt. Low Travel Speed 7.3 MPH, High Travel Speed 11.0 MPH	\$1,905.85	30.0%	\$1,334.09
-------------	---	------------	-------	------------

Part Number	Compact Track Loader Description	SLP in US\$	Discount Percent	Price
-------------	----------------------------------	-------------	------------------	-------

M0255	<b>T550 Compact Track Loader (equipped with Final Tier 4 Engine)</b>	\$50,517.76	30.0%	\$35,362.43
-------	--	-------------	-------	-------------

M0263	<b>T590 Compact Track Loader (equipped with Final Tier 4 engine)</b>	\$54,286.39	30.0%	\$38,000.47
-------	--	-------------	-------	-------------



Part Number	Air Conditioned/Heated Cab Packages Description	SLP in US\$	Discount Percent	Price
-------------	---	-------------	------------------	-------

M__-P01-A91	<b>A91 Option Package</b>	\$8,189.30	30.0%	\$5,732.51
-------------	---------------------------	------------	-------	------------

M__-P01-A71	<b>A71 Option Package</b>	\$5,994.34	30.0%	\$4,196.04
-------------	---------------------------	------------	-------	------------

M__-P01-A51	<b>A51 Option Package</b>	\$4,728.22	30.0%	\$3,309.76
-------------	---------------------------	------------	-------	------------

**A51**  
Enclosed Cab with AC/Heat  
Cab Accessories Package\*  
Power Bob-Tach

**A71**  
Enclosed Cab with AC/Heat  
Cab Accessories Package\*  
Power Bob-Tach

**A91**  
Enclosed Cab with AC/Heat  
Cab Accessories Pkg\*  
Power Bob-Tach

Sound Reduction  
 Deluxe Instrument Panel w/Keyless Start  
 Attachment Control Kit

Sound Reduction  
 Deluxe Instrument Panel  
 w/Keyless Start  
 Attachment Control  
 High Flow Hydraulics  
 Hydraulic Bucket Positioning  
 Two Speed w/ 3-Point Seat Belt

Part Number	Open Cab Packages Description	SLP in US\$	Discount Percent	Price
M__-P01-O51	O51 Option Package	\$1,150.27	30.0%	\$805.19

**O51**  
 Cab Accessories Package\*  
 Power Bob-Tach  
 \*Cab Accessories Package: Deluxe Headliner with Dome Light, Cab Accessory Harness, Power Port, Lower Interior Panels with Storage Compartments, and Cup Holder.

Part Number	Factory Installed Options Description	SLP in US\$	Discount Percent	Price
-------------	---------------------------------------	-------------	------------------	-------

Controls

M__-R01-C03	<b>Advanced Control System (ACS)</b> Allows operator to select either hand or foot control of lift and tilt functions.	\$1,436.31	30.0%	\$1,005.41
M__-R01-C04	<b>Selectable Joystick Control (SJC)</b> Standard features include: Selectable patterns (ISO or H-Pattern), Horsepower Management, Speed Management, Drive Response and Foot Pedal for Engine Speed Control.	\$2,619.39	30.0%	\$1,833.57
M__-R80-C02	<b>*IF a Cab Option Pkg is not ordered, a Cab Accessories Pkg must be ordered with ACS or SJC</b>	\$425.46	30.0%	\$297.82
<u>Other Factory Installed Options</u>				
M__-R05-C11	<b>Cloth Heated Air Ride Suspension Seat</b> Must order a Cab Option package.	\$321.91	30.0%	\$225.34
M__-R26-C02	<b>Radio</b> Must order a Cab Option package. Includes weatherproof AM/FM/NOAA Weather Band Radio, Speakers, and Antenna. Works with MP3 or other portable music player.	\$427.51	30.0%	\$299.26
M__-R03-C03	<b>High Flow Hydraulics</b> Provides 26.7 GPM and 3500 PSI for attachment operation. The 7 pin attachment control kit is required.	\$1,610.59	30.0%	\$1,127.41
M__-R28-C02	<b>7 Pin Attachment Control Kit</b> Required when ordering High Flow Hydraulics. Kit is included in A91, A71 Option Pkgs	\$210.17	30.0%	\$147.12
M__-R04-C02	<b>Two Speed - Incls 3 Pt Seat Belt</b>	\$1,905.85	30.0%	\$1,334.09
M__-R11-C02	<b>Hydraulic Bucket Positioning</b> Bucket Positioning helps the operator to keep the same tilt of the load during lifting. Includes On/Off switch.	\$479.79	30.0%	\$335.86

Track Options

M__-R09-C02	<b>16" Rubber Track</b> Compatible with Solid Mounted or Roller Suspension Carriages. Loader width is 70.1"	\$1,473.21	30.0%	\$1,031.25
M__-R21-C11	<b>Roller Suspension Carriage</b> Includes Solid Mounted undercarriage and 3 Rollers with Leaf Spring style suspension. Compatible with 12.6" tracks (Loader width 70.0") or 16" tracks (Loader width is 70.1")	\$1,679.28	30.0%	\$1,175.49

Part Number	Compact Track Loader Description	SLP in US\$	Discount Percent	Price
-------------	----------------------------------	-------------	------------------	-------

M0267	<b>T630 Compact Track Loader (equipped with Final Tier 4 engine)</b>	\$56,238.37	30.0%	\$39,366.86
M0271	<b>T650 Compact Track loader (equipped with Final Tier 4 engine)</b>	\$60,035.71	30.0%	\$42,025.00



Part Number	Air Conditioned/Heated Cab Packages Description	SLP in US\$	Discount Percent	Price
M__-P01-A91	A91 Option Package	\$8,189.30	30.0%	\$5,732.51
M__-P01-A71	A71 Option Package	\$5,994.34	30.0%	\$4,196.04
M__-P01-A51	A51 Option Package	\$4,728.22	30.0%	\$3,309.76

A51	A71	A91
Enclosed Cab with AC/Heat Cab Accessories Package* Power Bob-Tach	Enclosed Cab with AC/Heat Cab Accessories Package* Power Bob-Tach Sound Reduction Deluxe Instrument Panel with Keyless Start Attachment Control Kit	Enclosed Cab with AC/Heat Cab Accessories Package* Power Bob-Tach Sound Reduction Deluxe Instrument Panel with Keyless Start Attachment Control Kit High Flow Hydraulics Hydraulic Bucket Positioning Two Speed, 3 pt Seat Belt

Part Number	Open Cab Packages Description	SLP in US\$	Discount Percent	Price
M__-P01-O51	O51 Option Package	\$1,150.27	30.0%	\$805.19

O51
Cab Accessories Package* Power Bob-Tach <i>*Cab Accessories Package: Deluxe Headliner with Dome Light, Rear Cab Corner Trim, Cab Accessory Harness, Power Port, Lower Interior Panels with Storage Compartments and Cup Holder.</i>

Part Number	Factory Installed Options Description	SLP in US\$	Discount Percent	Price
<u>Controls</u>				
M__-R01-C03	<b>Advanced Control System (ACS)</b> Allows operator to select either hand or foot control of lift and tilt functions.	\$1,436.31	30.0%	\$1,005.41
M__-R01-C04	<b>Selectable Joystick Control (SJC)</b> Standard features include: Selectable patterns (ISO or H-Pattern), Horsepower Management, Speed Management, Drive Response and Foot Pedal for Engine Speed Control.	\$2,619.39	30.0%	\$1,833.57
M__-R80-C02	<b>*IF a Cab Option Pkg is not ordered, a Cab Accessories Pkg must be ordered with ACS or SJC</b>	\$425.46	30.0%	\$297.82
<u>Individual Options</u>				
M__-R05-C11	<b>Cloth Heated Air Ride Suspension Seat</b>	\$321.91	30.0%	\$225.34
M__-R26-C02	<b>Radio</b> Must order a Cab Option package. Includes weatherproof AM/FM/NOAA Weather Band Radio, Speakers, and Antenna. Works with MP3 or other portable music player.	\$427.51	30.0%	\$299.26
M__-R03-C03	<b>High Flow Hydraulics</b> Provides 30.5 GPM and 3500 PSI for attachment operation. The Bobcat Ordering systems will automatically add the 7 Pin Attachment Control Kit if the High Flow Hydraulics are ordered. Unless you are ordering a Cab Option Package that includes the Attachment Control Kit	\$1,610.59	30.0%	\$1,127.41
M__-R28-C02	<b>Attachment 7 Pin Control Kit</b> Required when ordering High Flow Hydraulics. Kit is included in A91, A71 Option Pkgs	\$210.17	30.0%	\$147.12
M__-R04-C02	<b>Two Speed</b> Two Speed Option includes 3-Point Seat Belt	\$2,060.65	30.0%	\$1,442.46
M__-R11-C02	<b>Hydraulic Bucket Positioning</b> Bucket positioning helps the operator to keep the same tilt of the load during lifting. Includes On/Off switch	\$479.79	30.0%	\$335.86
<u>Track Options</u>				
M__-R09-C02	<b>17.7" Rubber Tracks</b> Compatible with Solid Mounted or Roller Suspension Carriages - Loader Width 78.0"	\$1,473.21	30.0%	\$1,031.25
M__-R21-C11	<b>Roller Suspension Carriage</b> Includes Solid Mounted undercarriage and 4 Rollers with Leaf Spring style suspension. Compatible with 17.7" tracks. - Width 78"	\$1,679.28	30.0%	\$1,175.49

Part Number	Compact Track Loader Description	SLP in US\$	Discount Percent	Price
M0277	<b>T740 Compact Track loader (equipped with Final Tier 4 engine)</b>	\$67,025.53	30.0%	\$46,917.87





Part Number	Air Conditioned/Heated Cab Packages Description	SLP in US\$	Discount Percent	Price
M__-P01-A91	A91 Option Package	\$8,189.30	30.0%	\$5,732.51
M__-P01-A71	A71 Option Package	\$5,994.34	30.0%	\$4,196.04
M__-P01-A51	A51 Option Package	\$4,728.22	30.0%	\$3,309.76

A51	A71	A91
Enclosed Cab with AC/Heat Cab Accessories Package* Power Bob-Tach	Enclosed Cab with AC/Heat Cab Accessories Package* Power Bob-Tach Sound Reduction Deluxe Instrument Panel with Keyless Start Attachment Control Kit	Enclosed Cab with AC/Heat Cab Accessories Package* Power Bob-Tach Sound Reduction Deluxe Instrument Panel with Keyless Start Attachment Control Kit High Flow Hydraulics Hydraulic Bucket Positioning Two Speed, 3 pt Seat Belt

Part Number	Open Cab Packages Description	SLP in US\$	Discount Percent	Price
M__-P01-O51	O51 Option Package	\$1,150.27	30.0%	\$805.19

O51
Cab Accessories Package* Power Bob-Tach <i>* Cab Accessories Package: Deluxe Headliner with Dome Light, Rear Cab Corner Trim, Cab Accessory Harness, Power Port, Lower Interior Panels with Storage Compartments and Cup Holder.</i>

Part Number	Factory Installed Options Description	SLP in US\$	Discount Percent	Price
-------------	---------------------------------------	-------------	------------------	-------

<u>Controls</u>				
M__-R01-C04	<b>Selectable Joystick Control (SJC)</b> Standard features include: Selectable patterns (ISO or H-Pattern), Horsepower Management, Speed Management, Drive Response and Foot Pedal for Engine Speed Control.	\$2,619.39	30.0%	\$1,833.57
M__-R80-C02	<b>*IF a Cab Option Pkg is not ordered, a Cab Accessories Pkg must be ordered with ACS or SJC</b>	\$425.46	30.0%	\$297.82

<u>Individual Options</u>				
---------------------------	--	--	--	--

M__-R05-C11	<b>Cloth Heated Air Ride Suspension Seat*</b>	\$321.91	30.0%	\$225.34
M__-R26-C02	<b>Radio*</b> *Must order a Cab Option package. Includes weatherproof AM/FM/NOAA Weather Band Radio, Speakers, and Antenna. Works with MP3 or other portable music player.	\$427.51	30.0%	\$299.26

M__-R03-C03	<b>High Flow Hydraulics</b> Provides 30.5 GPM and 3500 PSI for attachment operation. The Bobcat Ordering systems will automatically add the 7 Pin Attachment Control Kit if the High Flow Hydraulics are ordered. Unless you are ordering a Cab Option Package that includes the Attachment Control Kit	\$1,610.59	30.0%	\$1,127.41
-------------	---	------------	-------	------------

M__-R28-C02	<b>Attachment 7 Pin Control Kit</b> Required when ordering High Flow Hydraulics. Kit is included in A91, A71 Option Pkgs	\$210.17	30.0%	\$147.12
-------------	--	----------	-------	----------

M__-R04-C02	<b>Two Speed</b> Two Speed Option includes 3-Point Seat Belt	\$2,060.65	30.0%	\$1,442.46
-------------	---	------------	-------	------------

M__-R11-C02	<b>Hydraulic Bucket Positioning</b> Bucket positioning helps the operator to keep the same tilt of the load during lifting. Includes On/Off switch	\$479.79	30.0%	\$335.86
-------------	--	----------	-------	----------

<u>Track Options</u>				
M__-R21-C11	<b>Roller Suspension Carriage</b> Includes Solid Mounted undercarriage and 4 Rollers with Leaf Spring style suspension. Compatible with 12.6" tracks (Loader width 73.4") or 17.7" tracks (Loader width 78").	\$1,679.28	30.0%	\$1,175.49

Part Number	Compact Track Loader Description	SLP in US\$	Discount Percent	Price
-------------	----------------------------------	-------------	------------------	-------

M0285	<b>T770 Compact Track Loader (equipped with Final Tier 4 engine)</b>	\$76,210.29	30.0%	\$53,347.20
-------	--	-------------	-------	-------------



Part Number	Air Conditioned/Heated Cab Packages Description	SLP in US\$	Discount Percent	Price
M__-P01-A71	A71 Option Package	\$5,994.34	30.0%	\$4,196.04
M__-P01-A61	A61 Option Package	\$4,876.88	30.0%	\$3,413.81

A61	A71
Enclosed Cab with AC/Heat Cab Accessories Package* Power Bob-Tach	Enclosed Cab with AC/Heat Cab Accessories Package* Power Bob-Tach

Cab Accessories Package*	Sound Reduction
Hydraulic Bucket Positioning	Deluxe Instrument Panel with Keyless Start
Two Speed, 3 pt Seat Belt	Attachment Control Kit

Part Number	Open Cab Packages Description	SLP in US\$	Discount Percent	Price
M__-P01-O61	<b>O61 Option Package</b> <b>O61</b> Cab Accessories Package* Power Bob-Tach Two Speed, 3 pt Seat Belt Hydraulic Bucket Positioning	\$2,178.55	30.0%	\$1,524.99

\* Cab Accessories Package: Deluxe Headliner with Dome Light, Cab Accessory Harness, Power Port, Lower Interior Panels with Storage Compartments and Cup Holder.

Part Number	Factory Installed Options Description	SLP in US\$	Discount Percent	Price
<u>Controls</u>				
M__-R01-C03	<b>Advanced Control System (ACS)*</b> Allows operator to select either hand or foot control of lift and tilt functions.	\$1,436.31	30.0%	\$1,005.41
M__-R01-C04	<b>Selectable Joystick Control (SJC)*</b> Standard features include: Selectable patterns (ISO or H-Pattern), Horsepower Management, Speed Management, Drive Response and Foot Pedal for Engine Speed Control.	\$2,619.39	30.0%	\$1,833.57
M__-R80-C02	<b>*IF a Cab Option Pkg is not ordered, a Cab Accessories Pkg must be ordered with ACS or SJC</b>	\$425.46	30.0%	\$297.82

<u>Individual Options</u>				
M__-R05-C11	<b>Cloth Heated Air Ride Suspension Seat</b> Must order a Cab Option Package.	\$321.91	30.0%	\$225.34
M__-R26-C02	<b>Radio</b> Must order a Cab Option Package. Includes weatherproof AM/FM/NOAA Weather Band Radio, Speakers, and Antenna. Works with MP3 or other portable music player.	\$427.51	30.0%	\$299.26
M__-R03-C03	<b>High Flow Hydraulics</b> Provides 36.5 GPM and 3500 PSI for attachment operation. When ordering High Flow Hydraulics, the Bobcat Ordering systems will automatically add the 7 Pin Attachment Control Kit.	\$1,610.59	30.0%	\$1,127.41
M__-R28-C02	<b>Attachment 7 Pin Control Kit</b> Required when ordering High Flow Hydraulics. Kit is included in A91, A71 Option Pkgs	\$210.17	30.0%	\$147.12
M__-R04-C02	<b>Two Speed</b> Includes 2-speed motors, Spring Applied/Pressure Release (SAPR) Brake and 3 point Seat Belt. Low Travel Speed 6.1 MPH, High Travel Speed 10.7 MPH	\$1,905.85	30.0%	\$1,334.09
M__-R11-C02	<b>Hydraulic Bucket Positioning</b> Bucket Positioning helps the operator to keep the same tilt of the load during lifting. Includes On/Off switch	\$479.79	30.0%	\$335.86
<u>Track Options</u>				
M__-R21-C11	<b>Roller Suspension Carriage</b> Includes Solid Mounted undercarriage and 4 Rollers with Leaf Spring style suspension. Compatible with 12.6" Tracks (Machine Width 73.4") or 17.7" Tracks. (Machine Width 78.0")	\$1,679.28	30.0%	\$1,175.49

Part Number	Compact Track Loader Description	SLP in US\$	Discount Percent	Price
M0293	<b>T870 Compact Track Loader (equipped with Final Tier 4 engine)</b>	\$84,275.54	30.0%	\$58,992.88



Part Number	Air Conditioned/Heated Cab Packages Description	SLP in US\$	Discount Percent	Price
M0__-P01-A91	<b>A91 Option Package</b>	\$8,678.32	30.0%	\$6,074.82
M0__-P01-A71	<b>A71 Option Package</b>	\$6,508.99	30.0%	\$4,556.30

A71	A91
Cab Accessories Package*	Cab Accessories Package*
Sound Reduction	Sound Reduction
Deluxe Instrument Panel with Keyless Start	Deluxe Instrument Panel with Keyless Start
Attachment Control Kit	Attachment Control Kit

High Flow Hydraulics  
Hydraulic Bucket Positioning

\* Cab Accessories Package: Deluxe Headliner with Dome Light, Cab Accessory Harness, Power Port, Lower Interior Panels with Storage Compartments and Cup Holder.

Part Number	Factory Installed Options Description	SLP in US\$	Discount Percent	Price
<u>Controls</u>				
M0293-R01-C04	<b>Selectable Joystick Control (SJC)</b>	\$1,327.63	30.0%	\$929.34

Standard features include: Selectable patterns (ISO or H-Pattern), Horsepower Management, Speed Management, Drive Response and Foot Pedal for Engine Speed Control.

***Individual Options***

<b>M0293-R05-C11</b>	<b>Cloth Heated Air Ride Suspension Seat</b> Must order an A, H or O Cab Package.	<b>\$321.91</b>	<b>30.0%</b>	<b>\$225.34</b>
<b>M0293-R26-C02</b>	<b>Radio</b> Must order an A, H or O Cab Package.	<b>\$427.51</b>	<b>30.0%</b>	<b>\$299.26</b>
Includes weatherproof AM/FM/NOAA Weather Band Radio, Speakers, and Antenna. Works with MP3 or other portable music player.				
<b>M0293-R03-C03</b>	<b>High Flow Hydraulics</b> Provides 37.4 GPM and 3500 PSI for attachment operation. When ordering High Flow Hydraulics, the Bobcat Ordering systems will automatically add a 7 Pin Attachment Control Kit.	<b>\$1,930.45</b>	<b>30.0%</b>	<b>\$1,351.32</b>
<b>M0293-R28-C02</b>	<b>Attachment 7 Pin Control Kit</b> Required when ordering High Flow Hydraulics. Kit is included in A91, A71 Option Pkgs	<b>\$210.17</b>	<b>30.0%</b>	<b>\$147.12</b>
<b>M0293-R11-C02</b>	<b>Hydraulic Bucket Positioning</b> Bucket Positioning helps the operator to keep the same tilt of the load during lifting. Includes On/Off switch	<b>\$479.79</b>	<b>30.0%</b>	<b>\$335.86</b>



Part Number	Angle Brooms Description	SLP in US\$	Discount Percent	Price
(S70) 6907000	<b>48" Angle Broom</b> (Manual Angle, 3-Positions: 30° Right, Left and Straight)	\$ 3,270.39	24.0%	\$2,485.49
(S450 S510, S550, S530, S570, S590, S595) (S630, S650, S740, S750, S770) (T450, T550, T590, T595) (A770) (T630, T650, T740, T750, T770)				
6905805	<b>68" Angle Broom</b> (Loader must be equipped with an Attachment Control Kit) (When used on loaders equipped with a 14-Pin Attachment Control Kit, a 14-Pin Attachment T-Harness Kit is required)	\$ 5,448.94	24.0%	\$4,141.19
(S510, S550, S550H, S530, S530H, S570, S570H, S590, S590H, S595, S595H) (S630, S650, S740, S750, S770, S850) (A770) (T550, T550H, T590, T590H, T595, T595H) (T630, T650, T740, T750, T770, T870)				
6905806	<b>84" Angle Broom</b> (Loader must be equipped with an Attachment Control Kit) (When used on loaders equipped with a 14-Pin Attachment Control Kit, a 14-Pin Attachment T-Harness Kit is required)	\$ 6,233.22	24.0%	\$4,737.24

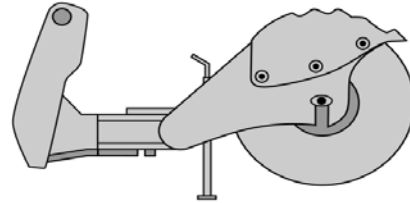



Part Number	Augers Description	SLP in US\$	Discount Percent	Price
-------------	--------------------	-------------	------------------	-------

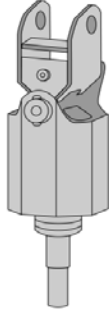

(S70, S450 S510, S550, S530, S570, S590) (T450)

6808799	<b>Model 10 Auger Drive Unit</b> (Must also order Mounting Frame and Bit) (Must order mounting frame, light duty bit and swing stop kit when installing on MT50 and MT52)	\$ 1,337.89	24.0%	\$1,016.79
---------	--	-------------	-------	------------

(S450, S510, S550, S530, S570, S590, S595)

(S630\*, S650\*, S740\*, S750\*, S770\*, S850\*) (A770\*)

(T450, T550, T590, T595) (T630\*, T650\*, T740\*, T750\*, T770\*, T870\*)

6809442	<b>Model 15C Auger Drive Unit</b> (Must also order Mounting Frame and Bit) (Auger drive unit is shipped with a 7/8" round bit retention pin, if used in conjunction with a hex bit a 5/8" Pin Kit P/N 6809733 is required.)	\$ 1,619.82	24.0%	\$1,231.06
---------	---	-------------	-------	------------

7145345	<b>Model 15H Hex Shaft Auger Drive Unit</b> (Must also order Mounting Frame and Bit)	\$ 1,619.82	24.0%	\$1,231.06
---------	---	-------------	-------	------------

(S450, S510, S550, S550H, S530, S530H, S570, S570H, S590, S590H, S595, S595H)

(S630\*, S630H\*, S650\*, S650H\*, S740\*, S750\*,

S750H\*, S770\*, S770H\*, S850\*, S850H\*) (A770\*, A770H\*)

(T450, T550, T550H, T590, T590H, T595, T595H)

(T630\*, T630H\*, T650\*, T650H\*, T740\*, T740H\*, T750\*, T750H\*, T770\*, T770H\*, T870\*, T870H\*)

6809445	<b>Model 30C Auger Drive Unit</b> (Must also order Mounting Frame and Bit) (Auger drive unit is shipped with a 7/8" round bit retention pin, if used in conjunction with a hex bit a 5/8" Pin Kit P/N 6809733 is required.)	\$ 2,173.42	24.0%	\$1,651.80
---------	---	-------------	-------	------------

7138264	<b>Model 30H Hex Shaft Auger Drive Unit</b> (Must also order Mounting Frame and Bit)	\$ 2,173.42	24.0%	\$1,651.80
---------	---	-------------	-------	------------

<b>6812946</b>	<b>Mounting Frame, 463, S70</b> (Includes Mounting Hardware)	\$	445.96	<b>24.0%</b>	<b>\$338.93</b>
 (S450-S595, S630-S850, A770, T450, T550, T590, T595, T630, T650, T740, T750, T770, T870)					
<b>6812980</b>	<b>Mounting Frame,</b> (Includes Mounting Hardware) <b>*Must also order Bumper Kit p/n 7172609 for M-Series Loaders – S630, S650, S870, T630, T650, T870</b> <b>*Must also order Swing Stop Kit, PN 6811444 for Mini-Track Loaders.</b> <b>*Auger Bits are not Included with the Auger Drive Units.</b>	\$	379.32	<b>24.0%</b>	<b>\$288.29</b>
 (S510, S530, S550, S570, S590, S595, S630, S650, S740, S750, S770, S850) (A770) (T550, T590, T595, T630, T650, T740, T750, T770, T870)					
<b>7220280</b>	<b>Model 35PH Planetary Auger Drive Unit</b> (Must also order Mounting Frame and Bit)	\$	3,301.14	<b>24.0%</b>	<b>\$2,508.87</b>
 (S550H, S570H, S590H, S595H, S630, S650, S740, S750, S770, S850) (A770) (T550H, T590H, T595H, T630, T650, T740, T750, T770, T870)					
<b>7227984</b>	<b>Model 50PH Planetary Auger Drive Unit</b> (Must also order Mounting Frame and Bit)	\$	3,859.88	<b>24.0%</b>	<b>\$2,933.51</b>
 (S510 - S850, A770, T550 - T870)					
<b>7223507</b>	<b>35PH/50PH Mounting Frame,</b> (Includes Mounting Hardware)	\$	476.72	<b>24.0%</b>	<b>\$362.31</b>

**Auger Drive & Bit Recommendations**

**Model 10 Augers—Recommended bit size 6", 9", 12", 15", 16", 18"**

**Model 15C and 30C Augers—Recommended bit size 6", 9", 12", 15", 18", 24", 30", 36"**

**Model 15H and 30H Augers—Recommended bit size 6", 9", 12", 15", 18", 24", 30", 36"**

**Model 35PH and 50PH Augers—Recommended bit size - HD - 8", 12", 18", 24", 30", 36", 48" And Rock Bits - 8", 12", 18", 24", 30"**

**Light Duty, Standard Duty, Heavy Duty and Rock Bits are Available.**

Auger bit combinations should be used as a guideline. Recommendations are based upon average digging conditions.

Part Number	Bob-Tach Mounted Backhoe Description	SLP in US\$	Discount Percent	Price
-------------	--------------------------------------	-------------	------------------	-------

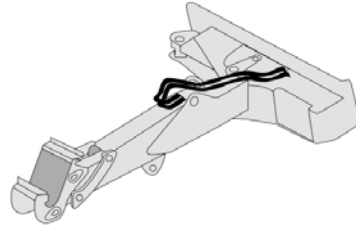

(S510, S550, S530, S570, S590, S595) (T550, T590, T595)

6906767	<b>Bob-Tach Mounted Backhoe</b> (Must also order bucket, see Backhoe Bucket pages) (Loader must be equipped with an Attachment Control Kit) (If installing on loader with 14-Pin Attachment Control, must also order 14-pin Attachment T-Harness P/N 6725383) (Bob-Tach Mounted Backhoe is NOT compatible with Rear Stabilizers)	\$ 4,756.93	24.0%	\$3,615.27
---------	---	-------------	-------	------------

Part Number	Accessories Description	SLP in US\$	Discount Percent	Price
-------------	-------------------------	-------------	------------------	-------

7104321	<b>Hydraulic Clamp</b> (Includes cylinder, hoses & pins)(Must also order Auxiliary Hydraulic Kit) (Price includes \$225 for installation)	\$ 1,599.31	24.0%	\$1,215.48
---------	---	-------------	-------	------------

Part Number	Backhoe Buckets Description	SLP in US\$	Discount Percent	Price
-------------	-----------------------------	-------------	------------------	-------

**Backhoe Buckets – Current**

(Bob-Tach Mounted Backhoe X-Change™ Style)

6735375	13" Trenching Bucket, 3 Bolt-On Teeth	\$ 604.87	24.0%	\$459.70
6735380	16" Trenching Bucket, 4 Bolt-On Teeth	\$ 635.62	24.0%	\$483.07
6735395	20" Trenching Bucket, 4 Bolt-On Teeth	\$ 686.88	24.0%	\$522.03

Part	Backhoe Buckets - 7BH, 9BH, 8811	SLP in US\$	Discount	Price
------	----------------------------------	-------------	----------	-------

Number	Description	SLP in US\$	Discount Percent	Price
(7BH)				
6735375	13" Trenching Bucket, 3 Bolt-On Teeth	\$ 604.87	24.0%	\$459.70
6735380	16" Trenching Bucket, 4 Bolt-On Teeth	\$ 635.62	24.0%	\$483.07
6735395	20" Trenching Bucket, 4 Bolt-On Teeth	\$ 686.88	24.0%	\$522.03

Part Number	Boring Unit Description	SLP in US\$	Discount Percent	Price
-------------	-------------------------	-------------	------------------	-------

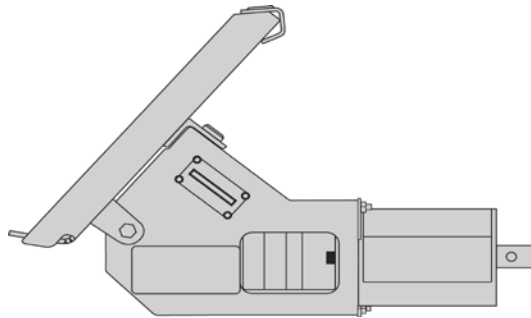

(S70)				
7110098	<b>Boring Unit</b> (Includes drive unit and guide tool) (Boring Tool Kit is available)	\$ 2,127.29	24.0%	\$1,616.74

Part Number	Box Blade Description	SLP in US\$	Discount Percent	Price
-------------	-----------------------	-------------	------------------	-------

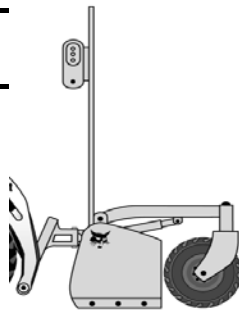





(S70)  
**7113419 HB680 Breaker**  
 (Includes Nail Point, fixing cap bolts, cradle, isolation mount, gauge tool, retainer clip and hose protector) (Must also order Loader Mounting Frame and Hose Kit)  
 (Special Applications Kit must be used when operating a Hydraulic Breaker)  
 (When installing on MT50, must also order Shutdown Kit, p/n 6735945)

\$ 4,541.64 24.0% \$3,451.64

**Mounting Frames – HB680**

**7113736 Loader Mounting Frame**  
 (Must also order a hose kit, P/N 6727411)

\$ 645.88 24.0% \$490.87

**7150181 Loader X-Change Mounting Frame**  
 (Uses X-Change pin-through design) (Must also order Breaker X-Change Mounting Cap p/n 7113656. This allows breaker with X-Change Mounting Cap to be installed on loader)  
 (Must also order a hose kit, P/N 6727411)

\$ 948.31 24.0% \$720.72

**7113656 X-Change Mounting Cap**

\$ 420.33 24.0% \$319.45

**Accessories – HB680**

**6727411 Hose Kit**  
 (Includes hoses and quick couplers)

\$ 184.54 24.0% \$140.25

Part Number	HB880 Breaker Description	SLP in US\$	Discount Percent	Price
-------------	---------------------------	-------------	------------------	-------

(S450, S510, S550, S530, S570, S590, S595) (T450, T550, T590, T595)

**7113420 HB880 Breaker**  
 (Includes Nail Point, flow control valve, fixing cap bolts, cradle, isolation mount, gauge tool, retainer clip and hose protector) (Must also order Loader Mounting Frame and Hose Kit)  
 (Special Applications Kit must be used when operating a Hydraulic Breaker)

\$ 6,433.13 24.0% \$4,889.18

**Mounting Frame – HB880**

**7113737 Loader Mounting Frame**

\$ 686.88 24.0% \$522.03

(Breaker mounting frame allows for breaking horizontal or vertical surfaces.)

(Must also order a hose kit, P/N 7114764)

**7113738**      **Horizontal Loader Mounting Frame**      \$      727.89      **24.0%**      **\$553.20**

(Recommended mounting frame for horizontal surface breaking only)

(Must also order a hose kit, P/N 7114764)

**7141800**      **Loader X-Change Mounting Frame**      \$      1,009.82      **24.0%**      **\$767.46**

Allows breaker with X-Change Mounting Cap to be installed on loader, breaker can then be

used on excavator and loader. Uses X-Change pin-through design.

(Breaker mounting frame allows for breaking horizontal or vertical surfaces)

(Must also order Breaker X-Change Mounting Cap P/N 7113657)

(Must also order a hose kit, P/N 7114764)

**7113657**      **X-Change Mounting Cap**      \$      420.33      **24.0%**      **\$319.45**

**Accessories – HB880**

**7114764**      **Hose Kit**      \$      210.17      **24.0%**      **\$159.73**

(Ship Weight 20 lbs.)

<b>Part Number</b>	<b>HB980 Breaker Description</b>	<b>SLP in US\$</b>	<b>Discount Percent</b>	<b>Price</b>
--------------------	----------------------------------	--------------------	-------------------------	--------------

(S450, S510, S550, S530, S570, S590, S595)

(S630\*, S650\*, S750\*, S740\*, S770\*) (A770\*)

(T450, T550, T590, T595) (T630\*, T650\*, T740\*, T750\*, T770\*)

**7113421**      **HB980 Breaker**      \$      8,058.07      **24.0%**      **\$6,124.13**

(Includes Nail Point, flow control valve, fixing cap bolts, cradle, isolation mount, gauge tool, retainer clip and hose protector)

(Must also order Loader Mounting Frame and Hose Kit)

(Special Applications Kit must be used when operating a Hydraulic Breaker)

**\*Must also order Flow Control Valve Kit, for M-Series p/n 7177744**

**Mounting Frame –HB980**

**7113737**      **Loader Mounting Frame**      \$      686.88      **24.0%**      **\$522.03**

(Breaker mounting frame allows for breaking horizontal or vertical surfaces.)

(Must also order a hose kit, P/N 7114764)

**7113738**      **Horizontal Loader Mounting Frame**      \$      727.89      **24.0%**      **\$553.20**

(Recommended mounting frame for horizontal surface breaking only)

(Must also order a hose kit, P/N 7114764)

**7141800**      **Loader X-Change Mounting Frame**      \$      1,009.82      **24.0%**      **\$767.46**

Allows breaker with X-Change Mounting Cap to be installed on loader, breaker can then be used on excavator and loader. Uses X-Change pin-through design.

(Breaker mounting frame allows for breaking horizontal or vertical surfaces)

(Must also order Breaker X-Change Mounting Cap P/N 7113657)

(Must also order a hose kit, P/N 7114764)

<b>7113657</b>	<b>X-Change Mounting Cap</b>	\$	420.33	<b>24.0%</b>	<b>\$319.45</b>
----------------	------------------------------	----	--------	--------------	-----------------

**Accessories –HB980**

<b>7114764</b>	<b>Hose Kit</b>	\$	210.17	<b>24.0%</b>	<b>\$159.73</b>
----------------	-----------------	----	--------	--------------	-----------------

Part Number	HB1180 Breaker Description	SLP in US\$	Discount Percent	Price
-------------	----------------------------	-------------	------------------	-------

(S630, S650, S740, S750, S770, S850) (A770)

(T630, T650, T740, T750, T770, T870)

<b>7115923</b>	<b>HB1180 Breaker</b>	\$	10,595.44	<b>24.0%</b>	<b>\$8,052.54</b>
----------------	-----------------------	----	-----------	--------------	-------------------

(Includes Nail Point, fixing cap bolts, cradle, isolation mount, gauge tool, retainer clip and hose protector) (Must also order Loader Mounting Frame and Hose Kit)  
(Special Applications Kit must be used when operating a Hydraulic Breaker)

**Mounting Frame –HB1180**

<b>7115937</b>	<b>Loader Mounting Frame</b>	\$	784.28	<b>24.0%</b>	<b>\$596.05</b>
----------------	------------------------------	----	--------	--------------	-----------------

(Breaker mounting frame allows for breaking horizontal or vertical surfaces.)  
(Must also order a hose kit, P/N 7114764)

<b>7141800</b>	<b>Loader X-Change Mounting Frame</b>	\$	1,009.82	<b>24.0%</b>	<b>\$767.46</b>
----------------	---------------------------------------	----	----------	--------------	-----------------

Allows breaker with X-Change Mounting Cap to be installed on loader, breaker can then be used on excavator and loader. Uses X-Change pin-through design.  
(Breaker mounting frame allows for breaking horizontal or vertical surfaces)  
(Must also order Breaker X-Change Mounting Cap P/N 7117325)  
(Must also order a hose kit, P/N 7114764)

<b>7117325</b>	<b>X-Change Mounting Cap</b>	\$	568.99	<b>24.0%</b>	<b>\$432.43</b>
----------------	------------------------------	----	--------	--------------	-----------------

**Accessories –HB1180**

<b>7114764</b>	<b>Hose Kit</b>	\$	210.17	<b>24.0%</b>	<b>\$159.73</b>
----------------	-----------------	----	--------	--------------	-----------------



Part Number	HB1380 Breaker Description	SLP in US\$	Discount Percent	Price
(S740, S750, S770, S850) (A770) (T740, T750, T770, T870) 7157576	<b>HB1380 Breaker</b> (Includes Nail Point, fixing cap bolts, cradle, isolation mount, gauge tool, retainer clip and hose protector) (Must also order Loader Mounting Frame and Hose Kit) (Special Applications Kit must be used when operating a Hydraulic Breaker)	\$ 13,148.19	24.0%	\$9,992.62
<b><u>Mounting Frame – HB1380</u></b>				
7115937	<b>Loader Mounting Frame</b> (Breaker mounting frame allows for breaking horizontal or vertical surfaces.) (Must also order a hose kit, P/N 7114764)	\$ 784.28	24.0%	\$596.05
7117325	<b>X-Change Mounting Cap</b>	\$ 568.99	24.0%	\$432.43
<b><u>Accessories – HB1380</u></b>				

7114764	Hose Kit	\$	210.17	24.0%	\$159.73
---------	----------	----	--------	-------	----------

Part Number	Description	SLP in US\$	Discount Percent	Price
-------------	-------------	-------------	------------------	-------

(S740, S750, S770, S850) (A770) (T740, T750, T770, T870)

7133203	<b>HB2380 Breaker</b>	\$	16,157.15	24.0%	\$12,279.44
---------	-----------------------	----	-----------	-------	-------------

(Includes Nail Point, fixing cap bolts, cradle, isolation mount, and hose protector)  
 (Must also order Loader Mounting Frame and Hose Kit)  
 (Special Applications Kit must be used when operating a Hydraulic Breaker)

Mounting Frames –HB2380

7115937	<b>Loader Mounting Frame</b>	\$	784.28	24.0%	\$596.05
---------	------------------------------	----	--------	-------	----------

(Breaker mounting frame allows for breaking horizontal or vertical surfaces.)  
 (Must also order a hose kit, P/N 7114764)

Accessories – HB2380

7114764	Hose Kit	\$	210.17	24.0%	\$159.73
---------	----------	----	--------	-------	----------

Part Number	Description	SLP in US\$	Discount Percent	Price
-------------	-------------	-------------	------------------	-------

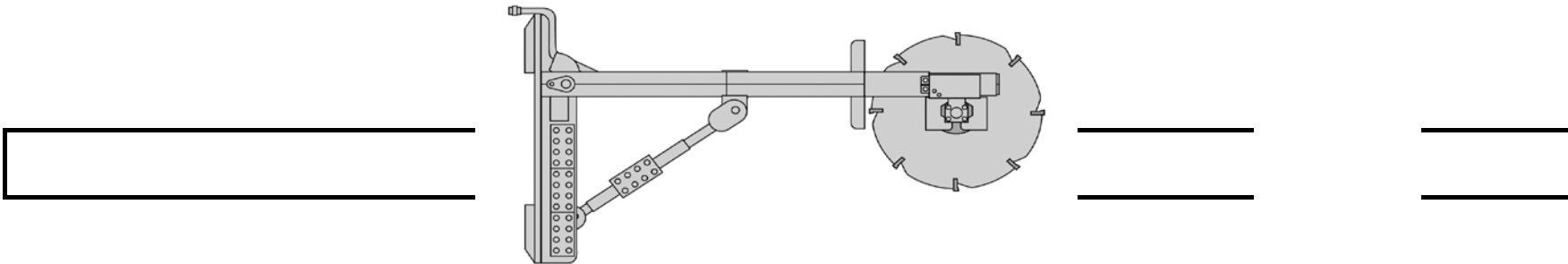

(S450, S510, S550, S530, S570, S590, S595)  
 (S630, S650, S740, S750, S770, S850) (A770)  
 (T450, T550, T590, T595) (T630, T650, T740, T750, T770, T870)

7121030	<b>Brush Saw</b>	\$	6,371.62	24.0%	\$4,842.43
---------	------------------	----	----------	-------	------------

(Special Applications kit must be installed on loader when operating Brush Saw)

Part Number	Brushcat Rotary Cutter Description	SLP in US\$	Discount Percent	Price
-------------	------------------------------------	-------------	------------------	-------

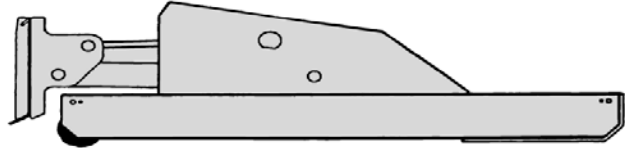

<b>(S450, S510, S530, S550, S530, S570, S590, S595) (T450, T550, T590, T595)</b>				
7234049	66" Brushcat Rotary Cutter, Standard Flow (RC66)	\$ 6,274.22	24.0%	\$4,768.41
<b>(S550H, S570H, S590H, S595H) (T550H, T590H, T595, T595H)</b>				
7233014	66" Brushcat Rotary Cutter, High Flow (RC66HF)	\$ 6,356.24	24.0%	\$4,830.74
<b>(S510, S530, S550, S570, S590, S595, S630, S650, S740, S750, S770) (A770)</b>				
<b>(T550, T590, T595, T630, T650, T740 T750, T770)</b>				
7218087	72" Brushcat Rotary Cutter, Standard Flow (RC72)	\$ 6,453.63	24.0%	\$4,904.76
<b>(S550H, S570H, S590H, S595H, S630H, S650H, S740H, S750H, S770H) (A770H)</b>				
<b>(T550H, T590H, T595H, T630H, T650H, T740H, T750H, T770H)</b>				
7233002	72" Brushcat Rotary Cutter, High Flow (RC72HF)	\$ 6,704.81	24.0%	\$5,095.65
<b>(S630H, S650H, S740H, S750H, S770H, S850H) (A770H)</b>				
<b>(T630H, T650H, T740H, T750H, T770H, T870H)</b>				
7233092	80" Brushcat Rotary Cutter, High Flow (RC80)	\$ 7,084.13	24.0%	\$5,383.94

Part Number	Buckets Description	SLP in US\$	Discount Percent	Price
-------------	---------------------	-------------	------------------	-------



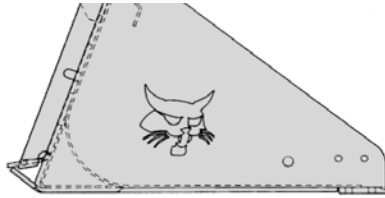

(S70)

7117432	36" Dirt Bucket ♦	\$	497.22	24.0%	\$377.89
7117433	44" Dirt Bucket ♦	\$	527.98	24.0%	\$401.26
7114488	36" General Purpose Bucket ♦	\$	543.36	24.0%	\$412.95
7114581	44" General Purpose Bucket ♦	\$	574.11	24.0%	\$436.33
7114583	50" General Purpose Bucket ♦	\$	599.74	24.0%	\$455.80

(S450)

6737399	56" Constr./Ind. Bucket ♦	\$	963.69	24.0%	\$732.40
6731403	62" Constr./Ind. Bucket ♦	\$	876.55	24.0%	\$666.17
6731406	68" Constr./Ind. Bucket ♦	\$	994.44	24.0%	\$755.78
6557599	54" Fertilizer & Grain Bucket D	\$	825.29	24.0%	\$627.22
6558681	60" Fertilizer & Grain Bucket D	\$	840.66	24.0%	\$638.90
7114584	56" General Purpose Bucket ♦	\$	661.25	24.0%	\$502.55
7114585	62" General Purpose Bucket ♦	\$	697.14	24.0%	\$529.82
7114586	68" General Purpose Bucket ♦	\$	712.51	24.0%	\$541.51
7114587	74" General Purpose Bucket ♦	\$	758.65	24.0%	\$576.57
7101903	56" Low Profile Bucket ♦	\$	973.94	24.0%	\$740.19
6731415	62" Low Profile Bucket ♦	\$	891.92	24.0%	\$677.86
6731418	68" Low Profile Bucket ♦	\$	1,004.70	24.0%	\$763.57
7184103	68" Snow & Light Material Bucket D	\$	1,148.22	24.0%	\$872.65
7184105	74" Snow & Light Material Bucket D	\$	1,214.86	24.0%	\$923.30

**D** Buckets have holes predrilled to accept bolt-on cutting edges.

**♦** Buckets have holes predrilled to accept bolt-on cutting edges or bolt-on teeth.

(S510, S550, S530, S570, S590, S595)

6731403	62" Constr./Ind. Bucket ♦	\$	876.55	24.0%	\$666.17
6731406	68" Constr./Ind. Bucket ♦	\$	994.44	24.0%	\$755.78
7124426	68" Constr./Ind. Heavy Duty Bucket ♦	\$	1,409.65	24.0%	\$1,071.33

(Recommended for severe-duty use  
 (Not approved for use with the 55" Farm Grapple P/N 7176977))

6731409	74" Constr./Ind. Bucket ♦	\$	1,076.46	24.0%	\$818.11
6558681	60" Fertilizer & Grain Bucket D	\$	840.66	24.0%	\$638.90
6706479	66" Fertilizer & Grain Bucket D	\$	1,045.70	24.0%	\$794.74
6706483	72" Fertilizer & Grain Bucket D	\$	1,214.86	24.0%	\$923.30
7114585	62" General Purpose Bucket ♦ (Only for S510, S530, S550, S570)	\$	697.14	24.0%	\$529.82
7114586	68" General Purpose Bucket ♦ (Only for S510, S530, S550, S570)	\$	712.51	24.0%	\$541.51
7114587	74" General Purpose Bucket ♦ (Only for S510, S530, S550, S570)	\$	758.65	24.0%	\$576.57
6731415	62" Low Profile Bucket ♦	\$	891.92	24.0%	\$677.86
6731418	68" Low Profile Bucket ♦	\$	1,004.70	24.0%	\$763.57
6731421	74" Low Profile Bucket ♦	\$	1,091.84	24.0%	\$829.80
7184103	68" Snow & Light Material Bucket D	\$	1,148.22	24.0%	\$872.65
7184105	74" Snow & Light Material Bucket D	\$	1,214.86	24.0%	\$923.30
7184110	80" Snow & Light Material Bucket D	\$	1,332.76	24.0%	\$1,012.90
7184098	88" Snow & Light Material Bucket D (S530, S570, S590 Only)	\$	1,419.90	24.0%	\$1,079.13
(S630, S650)					
6731406	68" Constr./Ind. Bucket ♦ (for use with offset rims only)	\$	994.44	24.0%	\$755.78
7124426	68" Constr./Ind. Heavy Duty Bucket ♦	\$	1,409.65	24.0%	\$1,071.33
Recommended for severe-duty use (Not approved for use with the 55" Farm Grapple P/N 7176977)					
6731409	74" Constr./Ind. Bucket ♦	\$	1,076.46	24.0%	\$818.11
6732305	74" Constr./Ind. Heavy Duty Bucket ♦	\$	1,460.91	24.0%	\$1,110.29
(Recommended for severe-duty use) (Not approved for use with the 55" Farm Grapple, P/N 7176977)					
6731412	80" Constr./Ind. Bucket ♦	\$	1,173.85	24.0%	\$892.13
6726344	80" Constr./Ind. Heavy Duty Bucket ♦	\$	1,573.68	24.0%	\$1,196.00
(Recommended for severe-duty use) (Not approved for use with the 55" Farm Grapple, P/N 7176977)					
7125917	84" Constr./Ind. Heavy Duty Bucket ♦	\$	1,650.57	24.0%	\$1,254.43
(For use with S650 only) (Recommended for severe-duty use) (Not approved for use with the 55" Farm Grapple, P/N 7176977)					
6706479	66" Fertilizer & Grain Bucket D (for use with offset rims only)	\$	1,045.70	24.0%	\$794.74
6706483	72" Fertilizer & Grain Bucket D	\$	1,214.86	24.0%	\$923.30
6731418	68" Low Profile Bucket ♦ (for use with offset rims only)	\$	1,004.70	24.0%	\$763.57
6731421	74" Low Profile Bucket ♦	\$	1,091.84	24.0%	\$829.80
6731424	80" Low Profile Bucket ♦	\$	1,189.23	24.0%	\$903.82
7184103	68" Snow & Light Material Bucket D	\$	1,148.22	24.0%	\$872.65
(For use with offset rims only)					

7184105	74" Snow & Light Material Bucket D	\$	1,214.86	24.0%	\$923.30
7184110	80" Snow & Light Material Bucket D	\$	1,332.76	24.0%	\$1,012.90
7184098	88" Snow & Light Material Bucket D	\$	1,419.90	24.0%	\$1,079.13
(S740, S750, S770)					
6731406	68" Constr./Ind. Bucket ♦ (For use with offset rims only)	\$	994.44	24.0%	\$755.78
7124426	68" Constr./Ind. Heavy Duty Bucket ♦ (S530, S570, S590 only) Recommended for severe-duty use (Not approved for use with the 55" Farm Grapple P/N 7176977)	\$	1,409.65	24.0%	\$1,071.33
6731409	74" Constr./Ind. Bucket ♦	\$	1,076.46	24.0%	\$818.11
6732305	74" Constr./Ind. Heavy Duty Bucket ♦ (Not approved for use with the 55" Farm Grapple, P/N 7176977)	\$	1,460.91	24.0%	\$1,110.29
6731412	80" Constr./Ind. Bucket ♦	\$	1,173.85	24.0%	\$892.13
6726344	80" Constr./Ind. Heavy Duty Bucket ♦ (Not approved for use with the 55" Farm Grapple, P/N 7176977)	\$	1,573.68	24.0%	\$1,196.00
7125917	84" Constr./Ind. Heavy Duty Bucket ♦ (Not approved for use with the 55" Farm Grapple, P/N 7176977)	\$	1,650.57	24.0%	\$1,254.43
6726328	88" Constr./Ind. Heavy Duty Bucket ♦ (Not approved for use with the 55" Farm Grapple, P/N 7176977)	\$	1,727.46	24.0%	\$1,312.87
7173162	82" Constr./Ind. Severe Duty Bucket ♦	\$	1,886.37	24.0%	\$1,433.64
7173161	88" Constr./Ind. Severe Duty Bucket ♦	\$	2,024.77	24.0%	\$1,538.83
6706483	72" Fertilizer & Grain Bucket D	\$	1,214.86	24.0%	\$923.30
6731418	68" Low Profile Bucket ♦ (for use with offset rims only)	\$	1,004.70	24.0%	\$763.57
6731421	74" Low Profile Bucket ♦	\$	1,091.84	24.0%	\$829.80
6731424	80" Low Profile Bucket ♦	\$	1,189.23	24.0%	\$903.82
7184103	68" Snow & Light Material Bucket D (For use with offset rims only)	\$	1,148.22	24.0%	\$872.65
7184105	74" Snow & Light Material Bucket D	\$	1,214.86	24.0%	\$923.30
7184110	80" Snow & Light Material Bucket D	\$	1,332.76	24.0%	\$1,012.90
7184098	88" Snow & Light Material Bucket D	\$	1,419.90	24.0%	\$1,079.13
6727787	100" Snow & Light Material Bucket ♦	\$	1,850.49	24.0%	\$1,406.37

**D** Buckets have holes predrilled to accept bolt-on cutting edges.

♦ Buckets have holes predrilled to accept bolt-on cutting edges or bolt-on teeth.

(S850)					
6726344	80" Constr./Ind. Heavy Duty Bucket ♦ (Not approved for use with the 55" Farm Grapple, P/N 7176977)	\$	1,573.68	24.0%	\$1,196.00
7125917	84" Constr./Ind. Heavy Duty Bucket ♦ (Not approved for use with the 55" Farm Grapple, P/N 7176977)	\$	1,650.57	24.0%	\$1,254.43
6726328	88" Constr./Ind. Heavy Duty Bucket ♦ (Not approved for use with the 55" Farm Grapple, P/N 7176977)	\$	1,727.46	24.0%	\$1,312.87

7173162	82" Constr./Ind. Severe Duty Bucket ♦	\$	1,886.37	24.0%	\$1,433.64
7173161	88" Constr./Ind. Severe Duty Bucket ♦	\$	2,024.77	24.0%	\$1,538.83
7184110	80" Snow & Light Material Bucket D	\$	1,332.76	24.0%	\$1,012.90
7184098	88" Snow & Light Material Bucket D	\$	1,419.90	24.0%	\$1,079.13
6727787	100" Snow & Light Material Bucket ♦	\$	1,850.49	24.0%	\$1,406.37
(A770)					
6731409	74" Constr./Ind. Bucket ♦	\$	1,076.46	24.0%	\$818.11
6732305	74" Constr./Ind. Heavy Duty Bucket ♦	\$	1,460.91	24.0%	\$1,110.29
	(Not approved for use with the 55" Farm Grapple, P/N 7176977)				
6731412	80" Constr./Ind. Bucket ♦	\$	1,173.85	24.0%	\$892.13
6726344	80" Constr./Ind. Heavy Duty Bucket ♦	\$	1,573.68	24.0%	\$1,196.00
	(Not approved for use with the 55" Farm Grapple, P/N 7176977)				
7125917	84" Constr./Ind. Heavy Duty Bucket ♦	\$	1,650.57	24.0%	\$1,254.43
	(Not approved for use with the 55" Farm Grapple, P/N 7176977)				
6726328	88" Constr./Ind. Heavy Duty Bucket ♦	\$	1,727.46	24.0%	\$1,312.87
	(Not approved for use with the 55" Farm Grapple, P/N 7176977)				
7173162	82" Constr./Ind. Severe Duty Bucket ♦	\$	1,886.37	24.0%	\$1,433.64
7173161	88" Constr./Ind. Severe Duty Bucket ♦	\$	2,024.77	24.0%	\$1,538.83
6706483	72" Fertilizer & Grain Bucket D	\$	1,214.86	24.0%	\$923.30
6731421	74" Low Profile Bucket ♦	\$	1,091.84	24.0%	\$829.80
6731424	80" Low Profile Bucket ♦	\$	1,189.23	24.0%	\$903.82
7184105	74" Snow & Light Material Bucket D	\$	1,214.86	24.0%	\$923.30
7184110	80" Snow & Light Material Bucket D	\$	1,332.76	24.0%	\$1,012.90
7184098	88" Snow & Light Material Bucket D	\$	1,419.90	24.0%	\$1,079.13
6727787	100" Snow & Light Material Bucket ♦	\$	1,850.49	24.0%	\$1,406.37

**D** Buckets have holes predrilled to accept bolt-on cutting edges.

**♦** Buckets have holes predrilled to accept bolt-on cutting edges or bolt-on teeth.

(T450)					
6737399	56" Constr./Ind. Bucket ♦	\$	963.69	24.0%	\$732.40
6731403	62" Constr./Ind. Bucket ♦	\$	876.55	24.0%	\$666.17
6731406	68" Constr./Ind. Bucket ♦	\$	994.44	24.0%	\$755.78
6557599	54" Fertilizer & Grain Bucket D	\$	825.29	24.0%	\$627.22
6558681	60" Fertilizer & Grain Bucket D	\$	840.66	24.0%	\$638.90

7101903	<b>56" Low Profile Bucket ♦</b>	\$	973.94	24.0%	\$740.19
6731415	<b>62" Low Profile Bucket ♦</b>	\$	891.92	24.0%	\$677.86
	(Must also order Side Edge Cutting kit p/n 6732094 when used with wide track option)				
6731418	<b>68" Low Profile Bucket ♦</b>	\$	1,004.70	24.0%	\$763.57
7184103	<b>68" Snow &amp; Light Material Bucket D</b>	\$	1,148.22	24.0%	\$872.65
7184105	<b>74" Snow &amp; Light Material Bucket D</b>	\$	1,214.86	24.0%	\$923.30
<b>(T550, T590, T595)</b>					
6731406	<b>68" Constr./Ind. Bucket ♦</b>	\$	994.44	24.0%	\$755.78
7124426	<b>68" Constr./Ind. Heavy Duty Bucket ♦</b>	\$	1,409.65	24.0%	\$1,071.33
	(S530, S570, S590 only) Recommended for severe-duty use				
	(Not approved for use with the 55" Farm Grapple P/N 7176977)				
6731409	<b>74" Constr./Ind. Bucket ♦</b>	\$	1,076.46	24.0%	\$818.11
	(Must also order Side Edge Cutting kit p/n 6732093 when used with wide track option)				
6732305	<b>74" Constr./Ind. Heavy Duty Bucket ♦</b>	\$	1,460.91	24.0%	\$1,110.29
	(Recommended for severe-duty use)				
	(Not approved for use with the 55" Farm Grapple, P/N 7176977)				
6706479	<b>66" Fertilizer &amp; Grain Bucket D</b>	\$	1,045.70	24.0%	\$794.74
6706483	<b>72" Fertilizer &amp; Grain Bucket D</b>	\$	1,214.86	24.0%	\$923.30
6731418	<b>68" Low Profile Bucket ♦</b>	\$	1,004.70	24.0%	\$763.57
6731421	<b>74" Low Profile Bucket ♦</b>	\$	1,091.84	24.0%	\$829.80
	(Must also order Side Edge Cutting kit p/n 6732094 when used with wide track option)				
7184103	<b>68" Snow &amp; Light Material Bucket D</b>	\$	1,148.22	24.0%	\$872.65
7184105	<b>74" Snow &amp; Light Material Bucket D</b>	\$	1,214.86	24.0%	\$923.30
7184110	<b>80" Snow &amp; Light Material Bucket D</b>	\$	1,332.76	24.0%	\$1,012.90
7184098	<b>88" Snow &amp; Light Material Bucket D</b>	\$	1,419.90	24.0%	\$1,079.13

**D** Buckets have holes predrilled to accept bolt-on cutting edges.

**♦** Buckets have holes predrilled to accept bolt-on cutting edges or bolt-on teeth.

<b>(T630, T650)</b>					
6731409	<b>74" Constr./Ind. Bucket ♦</b>	\$	1,076.46	24.0%	\$818.11
	(Must also order Side Edge Cutting kit p/n 6732093 when used with wide track option)				
6732305	<b>74" Constr./Ind. Heavy Duty Bucket ♦</b>	\$	1,460.91	24.0%	\$1,110.29
	(Not approved for use with the 55" Farm Grapple, P/N 7176977)				



6731412	<b>80" Constr./Ind. Bucket ♦</b>	\$	1,173.85	24.0%	\$892.13
6726344	<b>80" Constr./Ind. Heavy Duty Bucket ♦</b> (Not approved for use with the 55" Farm Grapple, P/N 7176977)	\$	1,573.68	24.0%	\$1,196.00
7125917	<b>84" Constr./Ind. Heavy Duty Bucket ♦</b> (Not approved for use with the 55" Farm Grapple, P/N 7176977)	\$	1,650.57	24.0%	\$1,254.43
6706483	<b>72" Fertilizer &amp; Grain Bucket D</b> (For use with narrow track only)	\$	1,214.86	24.0%	\$923.30
6731421	<b>74" Low Profile Bucket ♦</b> (Must also order Side Edge Cutting kit p/n 6732094 when used with wide track option)	\$	1,091.84	24.0%	\$829.80
6731424	<b>80" Low Profile Bucket ♦</b>	\$	1,189.23	24.0%	\$903.82
7184105	<b>74" Snow &amp; Light Material Bucket D</b>	\$	1,214.86	24.0%	\$923.30
7184110	<b>80" Snow &amp; Light Material Bucket D</b>	\$	1,332.76	24.0%	\$1,012.90
7184098	<b>88" Snow &amp; Light Material Bucket D</b>	\$	1,419.90	24.0%	\$1,079.13
<b>(T740, T750, T770)</b>					
6732305	<b>74" Constr./Ind. Heavy Duty Bucket ♦</b> (Not approved for use with the 55" Farm Grapple, P/N 7176977)	\$	1,460.91	24.0%	\$1,110.29
6726344	<b>80" Constr./Ind. Heavy Duty Bucket ♦</b> (Not approved for use with the 55" Farm Grapple, P/N 7176977)	\$	1,573.68	24.0%	\$1,196.00
7125917	<b>84" Constr./Ind. Heavy Duty Bucket ♦</b> (Not approved for use with the 55" Farm Grapple, P/N 7176977)	\$	1,650.57	24.0%	\$1,254.43
6726328	<b>88" Constr./Ind. Heavy Duty Bucket ♦</b> (Not approved for use with the 55" Farm Grapple, P/N 7176977)	\$	1,727.46	24.0%	\$1,312.87
7173162	<b>82" Constr./Ind. Severe Duty Bucket ♦</b>	\$	1,886.37	24.0%	\$1,433.64
7173161	<b>88" Constr./Ind. Severe Duty Bucket ♦</b>	\$	2,024.77	24.0%	\$1,538.83
6706483	<b>72" Fertilizer &amp; Grain Bucket D</b> (For use with narrow track only)	\$	1,214.86	24.0%	\$923.30
7184110	<b>80" Snow &amp; Light Material Bucket D</b>	\$	1,332.76	24.0%	\$1,012.90
7184098	<b>88" Snow &amp; Light Material Bucket D</b>	\$	1,419.90	24.0%	\$1,079.13
6727787	<b>100" Snow &amp; Light Material Bucket ♦</b>	\$	1,850.49	24.0%	\$1,406.37

**D Buckets have holes predrilled to accept bolt-on cutting edges.**

**♦ Buckets have holes predrilled to accept bolt-on cutting edges or bolt-on teeth.**

<b>(T870)</b>					
7125917	<b>84" Constr./Ind. Heavy Duty Bucket ♦</b> (Recommended for severe-duty use) (Not approved for use with the 55" Farm Grapple, P/N 7176977)	\$	1,650.57	24.0%	\$1,254.43
6726328	<b>88" Constr./Ind. Heavy Duty Bucket ♦</b> (Recommended for severe-duty use)	\$	1,727.46	24.0%	\$1,312.87

	(Not approved for use with the 55" Farm Grapple, P/N 7176977)			
<b>7173161</b>	<b>88" Constr./Ind. Severe Duty Bucket ♦</b>	\$	2,024.77	<b>24.0%</b>
	(Recommended for severe-duty use)			
<b>7184098</b>	<b>88" Snow &amp; Light Material Bucket D</b>	\$	1,419.90	<b>24.0%</b>
<b>6727787</b>	<b>100" Snow &amp; Light Material Bucket ♦</b>	\$	1,850.49	<b>24.0%</b>

**D** Buckets have holes predrilled to accept bolt-on cutting edges.

**♦** Buckets have holes predrilled to accept bolt-on cutting edges or bolt-on teeth.

<b>Part Number</b>	<b>Chipper Description</b>	<b>SLP in US\$</b>	<b>Discount Percent</b>	<b>Price</b>
--------------------	----------------------------	--------------------	-------------------------	--------------

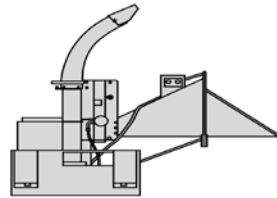

(S450, S510, S550, S530, S570, S590, S595) (A770)

(S630, S650, S740, S750, S770, S850) (T450, T550, T590, T595)

(T630, T650, T740, T750, T770, T870)

<b>6719129</b>	<b>5A Chipper</b>	\$	9,934.19	<b>24.0%</b>	<b>\$7,549.98</b>
----------------	-------------------	----	----------	--------------	-------------------

(Loader must be equipped with a 7 pin Attachment Control Kit)

(Attachment includes a 7-pin harness only) (Approved G-Series and newer Loaders only)

**5A Chipper must be installed on 700-800 Series BICS Loaders. Will not function on non-BICS loaders, 953s or 963s.**

(S550H, S570H, S590H, S595H) (A770H)

(S630H, S650H, S740H, S750H, S770H, S850H) (T550H, T590H, T595H)

(T630H, T650H, T740H, T750H, T770H, T870H)

<b>7117662</b>	<b>8B Chipper</b>	\$	12,497.19	<b>24.0%</b>	<b>\$9,497.86</b>
----------------	-------------------	----	-----------	--------------	-------------------

(Loader must be equipped with an 7-Pin Attachment Control Kit) (Approved G Series & New Loaders Only)

Part Number	Combination Bucket Description	SLP in US\$	Discount Percent	Price
-------------	--------------------------------	-------------	------------------	-------

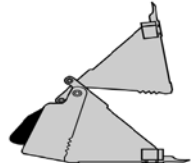

(S450, S510*, S550*, S530*, S570*) (T450)				
7167310	<b>62" Combination Bucket</b> (Bolt-on Teeth are available from Bobcat Dealer)	\$ 3,116.61	24.0%	\$2,368.62

(S510, S550, S530, S570, S590, S595) (S630*, S650*, S740*, S750*, S770*) (T550, T590)				
7167311	<b>68" Combination Bucket</b> (Bolt-on Teeth are available from Bobcat Dealer)	\$ 3,316.52	24.0%	\$2,520.56

(S510, S550, S530, S570, S590, S595) (S630, S650, S740, S750, S770) (A770) (T550, T590, T595) (T630, T650)				
7167312	<b>74" Combination Bucket</b> (Bolt-on Teeth are available from Bobcat Dealer)	\$ 3,495.93	24.0%	\$2,656.91

(S630, S650, S740, S750, S770) (A770) (T630, T650, T740, T750, T770)				
7167313	<b>80" Combination Bucket</b> (Bolt-on Teeth are available from Bobcat Dealer)	\$ 4,182.82	24.0%	\$3,178.94

(S740, S750, S770) (A770) (T650, T740, T750, T770)				
7167314	<b>84" Combination Bucket</b> (Bolt-on Teeth are available from Bobcat Dealer)	\$ 4,680.04	24.0%	\$3,556.83

**\*Requires Inset Rims**

Combination Buckets are not approved for use with the Tilt-Tatch.  
Combination Buckets may interfere with tracks at extreme roll-back position on some loaders. Use of lift-arm stop is required if this occurs.  
It is recommended that a port relief be installed for use with the Combination Buckets. Installation instructions are included in the Operation Manual.  
Optional Open/Close Restrictor is available to slow down the open/close functions of the combination bucket.

Part Number	Concrete Mixer Description	SLP in US\$	Discount Percent	Price
-------------	----------------------------	-------------	------------------	-------

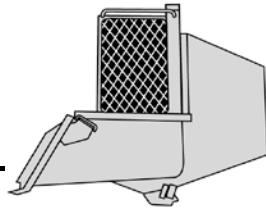

(S450, S510, S550, S530, S570, S590, S595, S630, S650, S740, S750, S770, S850)

(A770) (T450, T550, T590, T595, T650, T740, T750, T770, T870)

7186695	<b>Concrete Mixer - M-Series Compatible</b> (Loader must be equipped with an Attachment Control Kit) (F-Series and prior Loaders require Remote Attachment Control Kit) (Attachment includes a 7-Pin Harness only)	\$ 4,152.06	24.0%	\$3,155.57
---------	---	-------------	-------	------------

Part Number	Concrete Pump Description	SLP in US\$	Discount Percent	Price
-------------	---------------------------	-------------	------------------	-------

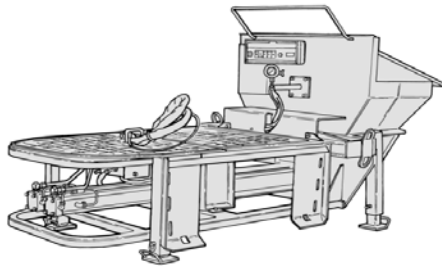

(S570, S570H, S590, S590H, S595, S595H)

(S630, S630H, S650, S650H, S740, S750, S750H, S770, S770H, S850, S850H)

(A770, A770H) (T550, T550H, T590, T590H, T595, T595H)

(T630, T630H, T650, T650H, T750, T750H, T770, T770H, T870, T870H)

7108693	<b>Concrete Pump</b> (Loader must be equipped with an Attachment Control Kit) (Attachment includes a 7-Pin Harness only) (May also need Delivery System Kit-unless customer has this equipment) Concrete Pump needs to be installed on 700-800, S570-S300, A220-A300, T550-T300 G-Series or newer BICS Loaders or 963 G-Series, will not function on F-Series or non-BICS loaders, 953s or 963 C-Series.	\$ 24,702.19	24.0%	\$18,773.67
---------	--	--------------	-------	-------------

Part Number	Accessories Description	SLP in US\$	Discount Percent	Price
6906079	<b>Delivery System Kit</b> (Includes 5" elbow, 5" to 3" reducer, (3) 25 ft. sections of 3" flexible hose, 3" x 6' flexible hose, (3) 3" x 10' steel lines, (2) 5" couplings, (8) 3" couplings, 3" cleanout ball) (Ship Weight 640 lbs.)	\$ 4,890.20	24.0%	\$3,716.56

6906813	<b>Remote Control Kit</b> (The hand held transmitter runs all functions of the Concrete Pump within a range of 200-400 feet from the pump.) <i>(Price includes \$90 for installation)</i>	\$ 1,958.13	24.0%	\$1,488.18
---------	---	-------------	-------	------------

Part Number	Digger Description	SLP in US\$	Discount Percent	Price
-------------	--------------------	-------------	------------------	-------

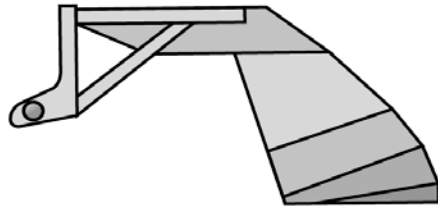

(S70)

7100915	<b>12S" Digger</b>	\$ 758.65	24.0%	\$576.57
---------	--------------------	-----------	-------	----------

(S450, S510, S550, S530, S570, S590, S595)

(S630, S650, S740, S750, S770) (A770) (T450, T550, T590, T595)

6719756	<b>25" Digger</b>	\$ 1,045.70	24.0%	\$794.74
6719757	<b>30" Digger</b>	\$ 1,102.09	24.0%	\$837.59
6719758	<b>36" Digger</b>	\$ 1,148.22	24.0%	\$872.65

Part Number	Dozer Blade Description	SLP in US\$	Discount Percent	Price
-------------	-------------------------	-------------	------------------	-------

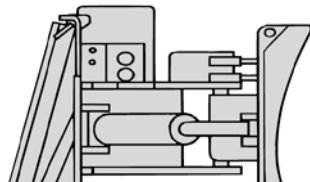



(S70)

7196165

**54" Utility Blade (with hydraulic angle)**

(To be used as either a Snow Blade or a Dozer Blade)

\$ 1,414.78 24.0% \$1,075.23

(S450, S510, S550, S530, S570, S590, S595) (S630, S650, S750, S770)

(T450, T550, T590, T595) (T630, T650)

6905884

**80" Dozer Blade, 6-Way**

(Loader must be equipped with an Attachment Control Kit)

(When used on loaders equipped with a 14-Pin Attachment Control Kit, a 14-Pin Attachment T-Harness Kit is required)

\$ 4,710.79 24.0% \$3,580.20

(S630, S650, S750, S770) (A770) (T630, T650)

6905811

**90" Dozer Blade, 6-Way**

(Loader must be equipped with an Attachment Control Kit)

(When used on loaders equipped with a 14-Pin Attachment Control Kit, a 14-Pin Attachment T-Harness Kit is required)

\$ 5,084.99 24.0% \$3,864.59

(S630, S650, S750, S770, S850) (A770)

(T630, T650, T740, T750, T770, T870)

7105781

**96" Dozer Blade, 6-Way**

(Loader must be equipped with an Attachment Control Kit)

(When used on loaders equipped with a 14-Pin Attachment Control Kit, a 14-Pin Attachment T-Harness Kit is required)

\$ 6,407.50 24.0% \$4,869.70

Part

**Drop Hammer**

SLP in US\$

Discount

Price

Number

Description

Percent

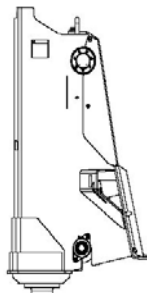

(S530, S570, S590, S595, (S630, S650, S740, S750, S770, S850) (A770)

(T550, T590, T630, T650, T750, T770, T870)

7137810	Drop Hammer	\$	8,324.62	24.0%	\$6,326.71
---------	-------------	----	----------	-------	------------

Part Number	Dumping Hopper Description	SLP in US\$	Discount Percent	Price
-------------	----------------------------	-------------	------------------	-------

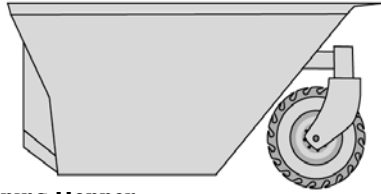

(S70)

6727275	<b>Model 10 Dumping Hopper</b>	\$	3,055.10	24.0%	\$2,321.87
---------	--------------------------------	----	----------	-------	------------

(Includes 8.5 x 12 Bobcat Heavy Duty Tire. Tire is not installed on Dumping Hopper.)

(S510, S550, S530, S570, S590, S595, S630, S650, S740, S750, S770, S850)

(A770) (T450, T550, T590, T595, T630, T650, T740, T750, T770, T870)

6717597	<b>Model 25 Dumping Hopper</b>	\$	4,726.17	24.0%	\$3,591.89
---------	--------------------------------	----	----------	-------	------------

(Includes 8.5 x 12 Bobcat Heavy Duty Tires. Tires are not installed on Dumping Hopper.)

Part Number	Flail Cutter Description	SLP in US\$	Discount Percent	Price
-------------	--------------------------	-------------	------------------	-------

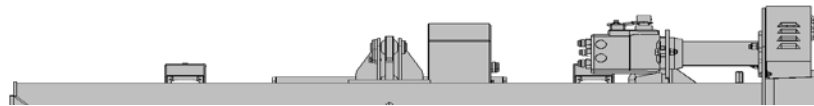

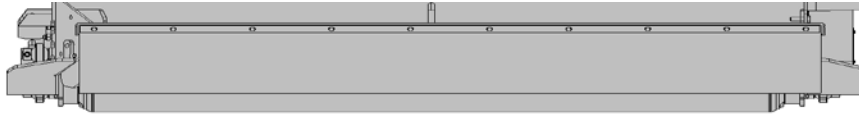

(S530, S530H, S570, S570H, S590, S590H, S595, S595H)

(S630, S630H, S650, S650H, S740, S740H, S750, S750H, S770, S770H, S850, S850H) (A770, A770H) (T550, T550H, T590, T590H, T595, T595H)

(T630, T630H, T650, T650H, T740, T740H, T750, T750H, T770, T770H, T870, T870H)

7101894      FC200 Flail Cutter      \$    11,400.22      24.0%      \$8,664.17

Part Number	Forestry Cutter Description	SLP in US\$	Discount Percent	Price
-------------	-----------------------------	-------------	------------------	-------

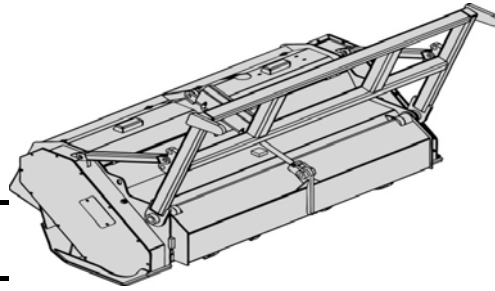

(S750H, S770H, S850H) (A300H) (A770H)

(T750H, T770H, T870H)

7194306      Forestry Cutter, 50"      \$    25,086.64      24.0%      \$19,065.85

- Must also order Forestry Applications Kit, for K-Series Loaders, p/n 7131810
- For M-Series Loaders (S750H, S770H, S850H, A770H, T750H, T770H, T870H) must order Forestry Apps Kit, PN 7174126
- Loader must be equipped with high flow and certain K-Series SN'd Loaders must be equipped with a upgraded cooling system

(The following K-Series loader serial numbers must be equipped with the cooling system upgrade kit p/n 7126319: A300, SN 539911675 & below;  
 T300 s/n 532015066 & below; T250 s/n 531812826 & below; S300 s/n 531115051 & below) (All S330 Loader are equipped with upgrade cooling system)  
 For Certain SN'd A300, S300, S330, T250, T300, T320 Loaders must also order Door Wiring Harness - Will need to provide Serial No of machine

(S750H, S770H, S850H) (A300H) (A770H)

(T750H, T770H, T870H)

7194305      Forestry Cutter, 60"      \$    26,378.40      24.0%      \$20,047.58

- For K-Series Loaders (S300H, S330H, A300H, T250H, T300H, T320H)
- Must also order Forestry Applications Kit, K-Series p/n 7131810
- For M-Series Loaders (S750H, S770H, S850H, A770H, T750H, T770H, T870H)  
 must also order Forestry Applications Kit, M-Series p/n 7174126





**Kit is required to operate Forestry Cutter and provides operator & machine protection.**

**\*\*Must also order Engine Seal Kit**

**Not compatible with rear auxiliary hydraulics.**

Kit includes: Forestry Door (3/4 in. laminated polycarbonate), Front and Rear Light Guards, Hydraulic Quick Coupler Guard, Fire Extinguisher, Level II FOPS, Muffler Guard, Lift Cylinder Debris Shields, Top and Rear Windows, Polycarbonate Side Windows

(Add \$990.00 for installation to discounted price)

NOTE: K-Series Loaders must be equipped with PN 7131810 - Forestry Applications Kit - please call for pricing

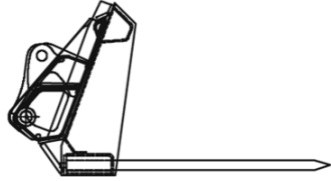
Part Number	Forks, Utility Description	SLP in US\$	Discount Percent	Price
(S70) 6727904	 <p><b>36" Utility fork, with 5 Teeth</b> (Use with Farm/Utility grapple P/N 6728117) (Additional Forks (p/n 6717622) may be Ordered)</p>	\$ 768.90	24.0%	\$584.36
(S70, S450) (T450) 6727888	<p><b>54" Utility fork, with 7 Teeth</b> (Use with Farm/Utility grapple P/N 6728117) (Additional Forks (p/n 6717622) may be ordered)</p>	\$ 917.55	24.0%	\$697.34
(S450, S510, S550, S530, S570, S590, S595, S630, S650) (T450, T550, T590, T595) 6725178	<p><b>60" Utility fork, with 8 Teeth</b> (Use with Farm/Utility grapple P/N 7176977) (Additional Forks (p/n 6717622) may be ordered)</p>	\$ 1,014.95	24.0%	\$771.36
(S450, S510, S550, S530, S570, S590, S595, S630, S650) (T450, T550, T590, T595) 6725179	<p><b>66" Utility fork, with 9 Teeth</b> (Use with Farm/Utility grapple P/N 7176977) (Additional Forks (p/n 6717622) may be ordered)</p>	\$ 1,117.47	24.0%	\$849.28
(S510, S550, S530, S570, S590, S595, S630, S650, S740, S750, S770) (A770) (T450, T550, T590, T595) (T630, T650) 6725180	<p><b>72" Utility fork, with 10 Teeth</b> (Use with Farm/Utility grapple P/N 7176977) (Additional Forks (p/n 6717622) may be ordered)</p>	\$ 1,266.12	24.0%	\$962.25

(S530, S570, S590, S595, S630, S650, S740, S750, S770)

(A770) (T550, T590, T595) (T630, T650)

**7107243**      **80" Utility fork, with 11 Teeth**      \$      1,486.54      **24.0%**      **\$1,129.77**  
(Use with Farm/Utility grapple P/N 7176977) (Additional Forks (p/n 6717622) may be ordered)

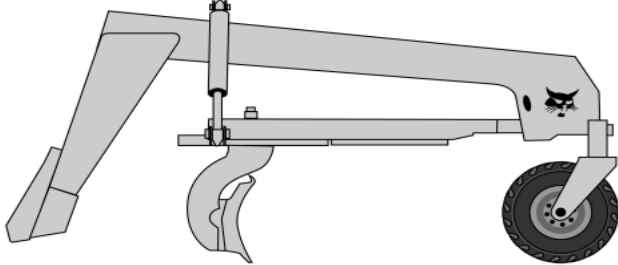
Part Number	Grader Description	SLP in US\$	Discount Percent	Price
				

(S450, S510, S550, S530, S570, S590, S595, S630, S650, S740, S750, S770)

(A770) (T450, T550, T590, T595)

**6906480**      **Grader, 84"**      \$      8,309.25      **24.0%**      **\$6,315.03**  
(Loader must be equipped with an Attachment Control Kit)  
(When used on loaders equipped with a 14-Pin Attachment Control Kit, a 14-Pin Attachment T-Harness Kit P/N 7164095 is required)

(S740, S750, S770, S850) (A770) (T650, T740, T750, T770, T870)

**7160005**      **Grader,96"**      \$      13,245.58      **24.0%**      **\$10,066.64**  
(Loader must be equipped with an Attachment Control Kit)  
(When used on loaders equipped with a 14-Pin Attachment Control Kit, a 14-Pin Attachment T-Harness Kit P/N 7164095 is required)

(S740, S750, S770, S850) (A770) (T740, T750, T770, T870)

**7182060**      **Grader, 108"**      \$      13,696.67      **24.0%**      **\$10,409.47**  
(Loader must be equipped with an Attachment Control Kit)  
(When used on loaders equipped with a 14-Pin Attachment Control Kit, a 14-Pin Attachment T-Harness Kit P/N 7164095 is required)

Part Number	Accessories Description	SLP in US\$	Discount Percent	Price
7164094	<b>Laser Mounting Kit, BLR2 (must also order 2 receivers)</b> (For 84" Grader) (Must also order two laser receivers, p/n 7160486) (Approved for use on Graders S/N 64801631 & above, started production April 2009) (Includes two receiver poles and wiring harnesses) (Price includes \$225 for installation)	\$ 897.05	24.0%	\$681.76
7177685	<b>Laser Mounting Kit</b> (For 96" and 108" Grader) (Must also order two laser receivers, p/n 7160486) (Includes two receiver poles and wiring harnesses) (Price includes \$225 for installation)	\$ 938.06	24.0%	\$712.92
7211624	<b>Sonic Tracer and Slope Sensor Mounting Kit</b> (For 96" and 108" Grader) (Must also order Sonic Tracer and Slope Sensor Pkg, PN 7023454) Incls Mounting Brackets, hardware and wiring harnesses (not compatible with end wing kit)	\$ 1,737.71	24.0%	\$1,320.66
7160486	<b>Laser Receiver, BLR2</b> (Must order 2 for use with laser kit) (May also need a laser transmitter and tripod—unless customer has this equipment.) (The laser receivers will work with most rotating laser transmitters, for full functionality a dual slope-rotating transmitter is recommended.)(Approved for use on Graders S/N 648001631 & above, started production April 2009, and 96" and 108" Graders)	\$ 1,988.89	24.0%	\$1,511.55
7023454	<b>Sonic Tracer and Slope Sensor Package</b> (Approved for 96" and 108" Graders) (Must also order Sonic Tracer and Slope Mounting Kit, PN 7211624) Incls ST400 Sonic Tracer, AS400 Slope Sensor (qty 2) and RS400 Rotation Sensor (Use where laser transmitters won't work because of obstructions or where grader must follow predetermined slopes and land contours)	\$ 9,272.93	24.0%	\$7,047.43
7177684	<b>End Wing Kit</b> (Converts graders 96" and 108" into box blade for finish grading only) (Not compatible with the Sonic Tracer)	\$ 435.71	24.0%	\$331.14
6680073	<b>Laser Transmitter, Dual Slope</b> (Trimble GL722)	\$ 7,720.00	24.0%	\$5,867.20
7275232	<b>Laser Transmitter, Dual Slope</b> (Trimble GL422N; includes CR600 receiver)	\$ 2,357.96	24.0%	\$1,792.05
7275231	<b>Laser Transmitter, Single Slope</b> (Trimble GL412N)	\$ 1,978.64	24.0%	\$1,503.76



(Price includes \$270 for installation)

(S510, S550, S530, S570)				
--------------------------	--	--	--	--

7176783	<b>Grapple, 55" Utility - GP</b>	\$	1,512.17	24.0%	\$1,149.25
---------	----------------------------------	----	----------	-------	------------

(Fits 62", 68" and 74" **General Purpose** buckets)

(Price includes \$270 for installation)

Part Number	Grapple, Industrial Description	SLP in US\$	Discount Percent	Price
-------------	---------------------------------	-------------	------------------	-------

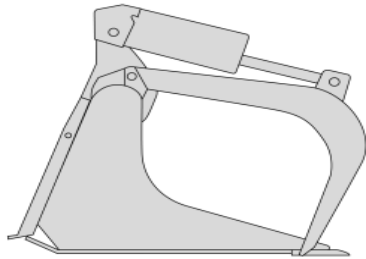

*Industrial Bucket Grapple*

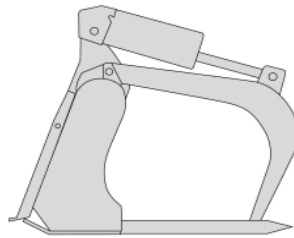

*Industrial Fork Grapple*

(S70) 7135737	<b>36" Industrial Bucket Grapple</b> (Bolt-On Cutting Edge included)	\$	1,840.23	24.0%	\$1,398.58
------------------	---	----	----------	-------	------------

(S450, S510, S550, S530, S570, S590, S595) (T450, T550, T590, T595) 7168342	<b>62" Industrial Bucket Grapple</b> (Bolt-On Cutting Edge included)	\$	3,296.02	24.0%	\$2,504.97
--	---	----	----------	-------	------------

(S450, S510, S550, S530, S570, S590, S595, S630, S650, S740, S750, S770) (T450, T550, T590, T595) (T630, T650) 7168340	<b>68" Industrial Bucket Grapple</b> (Bolt-On Cutting Edge included)	\$	3,470.30	24.0%	\$2,637.43
--	---	----	----------	-------	------------

(S450, S510, S550, S530, S570, S590, S595, S630, S650, S740, S750, S770)  
(T450, T550, T590, T595) (T630, T650)

7168344	66" Industrial Fork Grapple, with 7 teeth	\$	4,059.79	24.0%	\$3,085.44
---------	---	----	----------	-------	------------

(S630, S650, S740, S750, S770) (A770) (T550, T590, T595) (T630, T650)					
7168290	74" Industrial Bucket Grapple	\$	3,675.34	24.0%	\$2,793.26

(Bolt-On Cutting Edge included)

(S630, S650, S740, S750, S770, S850) (A770)  
(T630, T650, T740, T750, T770, T870)

7166624	78" Industrial Fork Grapple, with 8 teeth	\$	5,223.39	24.0%	\$3,969.78
---------	---	----	----------	-------	------------

(S630, S650, S740, S750, S770, S850) (A770)  
(T630, T650, T740, T750, T770, T870)

7168339	80" Industrial Bucket Grapple	\$	5,018.35	24.0%	\$3,813.95
---------	-------------------------------	----	----------	-------	------------

(Bolt-On Cutting Edge included)

It is recommended that a port relief be installed for use with grapples. Installation instructions are included in the Operation Manual.

Optional Open/Close Restrictor is available to slow down the open/close functions of the combination bucket.

Part Number	Grapple, Root Description	SLP in US\$	Discount Percent	Price
-------------	---------------------------	-------------	------------------	-------

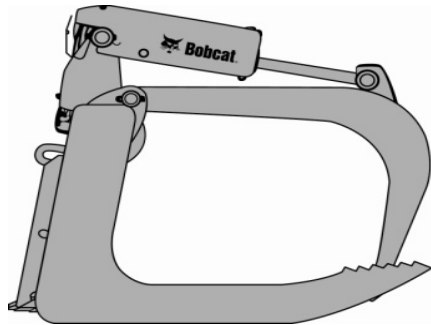

(S70) 7134179	36" Root Grapple	\$	1,870.99	24.0%	\$1,421.95
------------------	------------------	----	----------	-------	------------

(S510, S550, S530, S570, S590) (T450, T550, T590, T595) 7168343	66" Root Grapple	\$	3,060.22	24.0%	\$2,325.77
--	------------------	----	----------	-------	------------

(S530, S570, S590, S595, S630, S650, S740, S750, S770) (A770)

(T550, T590, T595, T630, T650, T740, T750, T770)

7165486 72" Root Grapple \$ 3,372.91 24.0% \$2,563.41

(S530, S570, S590, S595, S630, S650, S740, S750, S770, S850) (A770)

(T550, T590, T595) (T630, T650, T740, T750, T770, T870)

7168338 82" Root Grapple \$ 3,695.85 24.0% \$2,808.84

Operation Manual.

Optional Open/Close Restrictor is available to slow down the open/close functions of the combination bucket.

Part Number	Landplane Description	SLP in US\$	Discount Percent	Price
-------------	-----------------------	-------------	------------------	-------

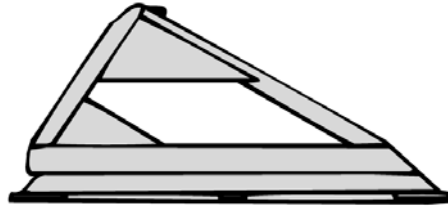

(S70)

6907173 48" Deluxe Landplane Leveling Attachment \$ 1,184.11 24.0% \$899.92

(Includes expanded metal grate, scarifier assembly, teeth and respective hardware)

(S450, S510, S550, S530, S570, S590, S595)

(S630, S650, S750, S770)

(A770) (T450, T550, T590, T595) (T630, T650)

6906150 72" Deluxe Landplane Leveling Attachment \$ 2,050.40 24.0% \$1,558.30

(Includes expanded metal grate, scarifier assembly, teeth and respective hardware)

(S450, S510, S550, S530, S570, S590, S220, S250, S300, S330) (S630, S650, S750, S770)

(A770) (T450, T550, T590, T595, T250, T300, T320) (T630, T650, T740, T750, T770)

6906115 78" Deluxe Landplane Leveling Attachment \$ 2,183.68 24.0% \$1,659.59

(Includes expanded metal grate, scarifier assembly, teeth and respective hardware)



<b>Part Number</b>	<b>Landscape Rake Description</b>	<b>SLP in US\$</b>	<b>Discount Percent</b>	<b>Price</b>
------------------------	---------------------------------------	--------------------	-----------------------------	--------------

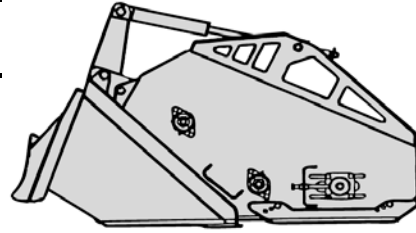

(S450, S510, S550, S530, S570, S590 S595) (S630, S650) (T450, T550, T590) (T630, T650)  
 6709107 5B Landscape Rake

\$ 7,530.09 24.0% \$5,722.87

(S510, S550, S530, S570, S590, S595, S630, S650, S740, S750, S770)  
 (A770) (T550, T590, T595) (T630, T650, T740, T750, T770)  
 6710630 6B Landscape Rake

\$ 7,827.40 24.0% \$5,948.83

Part Number	Mower, Finish Description	SLP in US\$	Discount Percent	Price
-------------	---------------------------	-------------	------------------	-------

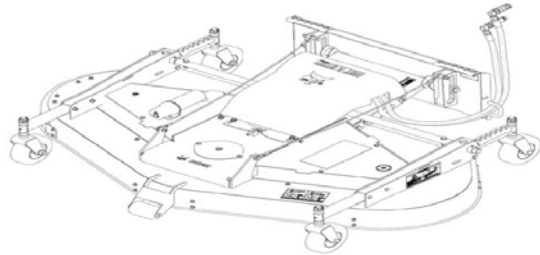

(S450, S510, S550, S530, S570, S590, S595)

(S630, S650, S740, S750, S770)

(A770) (T450, T550, T590, T595) (T630, T650, T740, T750, T770)

7144850	72" Mower	\$	5,018.35	24.0%	\$3,813.95
---------	-----------	----	----------	-------	------------

(S510, S550, S530, S570, S590, S595, S630, S650, S740, S750, S770, S850)

(A770) (T550, T590, T595) (T630, T650, T740, T750, T770, T870)

7143993	90" Mower	\$	5,489.95	24.0%	\$4,172.36
---------	-----------	----	----------	-------	------------

Part Number	Packer Wheel Description	SLP in US\$	Discount Percent	Price
-------------	--------------------------	-------------	------------------	-------

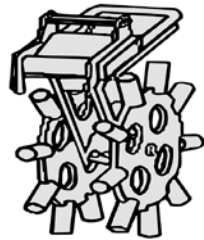

(S450, S510, S530, S550, S570, S590, S595, S630, S650, S740, S750, S770, S850) (A770) (T450, T550, T590, T595)

(T630, T650, T750, T770, T870)

6806644	Packer Wheel (Must also order loader x-change mounting frame p/n 7141800)	\$	2,070.90	24.0%	\$1,573.89
---------	--	----	----------	-------	------------

Part Number	Accessories Description	SLP in US\$	Discount Percent	Price
-------------	-------------------------	-------------	------------------	-------

7141800	Loader X-Change Mounting Frame	\$	1,009.82	24.0%	\$767.46
---------	--------------------------------	----	----------	-------	----------

Part Number	Pallet Forks Description	SLP in US\$	Discount Percent	Price
-------------	--------------------------	-------------	------------------	-------

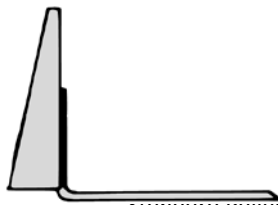

Standard Pallet Fork Teeth and Frame

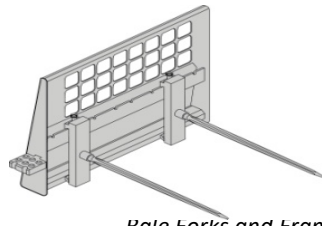

Bale Forks and Frame

7297499	2.5K STANDARD DUTY PALLET FORK FRAME, LESS TEETH	\$	435.71	24.0%	\$331.14
---------	--	----	--------	-------	----------

7294305	4K HEAVY DUTY PALLET FORK FRAME, LESS TEETH	\$	435.71	24.0%	\$331.14
7294332	5.5K SEVERE DUTY PALLET FORK FRAME, LESS TEETH	\$	1,178.98	24.0%	\$896.02

Bale Forks

6815781	Bale Forks, Set of 2	\$	610.00	24.0%	\$463.60
---------	----------------------	----	--------	-------	----------

Pallet Forks

7308798	42", 2.5K STANDARD DUTY I	\$	384.45	24.0%	\$292.18
6540183	42", 4K HEAVY DUTY PALLI	\$	369.07	24.0%	\$280.49
6540182	48", 4K HEAVY DUTY PALLI	\$	389.58	24.0%	\$296.08
6541521	42", 5.5K SEVERE DUTY PAL	\$	533.10	24.0%	\$405.16
6541518	48", 5.5K SEVERE DUTY PAL	\$	563.86	24.0%	\$428.53

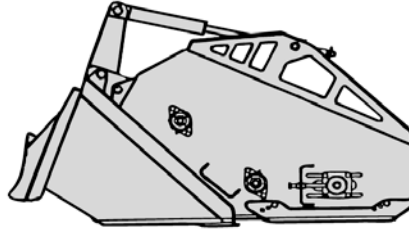

(STANDARD DUTY, HEAVY DUTY, SEVERE DUTY)

*(Quantity orders only on PN 7306978 in multiples of 5 only) (Compatible with Standard, Heavy and Severe Duty Frames)*

(SEVERE DUTY)

7306981 BRICK-GUARD EXTENSION

*(Quantity orders only on PN 7306978 in multiples of 5 only) (Compatible with Severe Duty Frames Only)*

Part Number	Pallet Forks, Hydraulic Description	SLP in US\$	Discount Percent	Price
-------------	-------------------------------------	-------------	------------------	-------

(S450, S510, S550, S530, S570, S590, S595) (A770)

(S630, S650, S740, S750, S770, S850)

(T450, T550, T590, T595) (T630, T650, T740, T750, T770)

6905425	48" Hydraulic Pallet Fork (Includes back frame and 2 hydraul	\$	2,973.08	24.0%	\$2,259.54
---------	---	----	----------	-------	------------

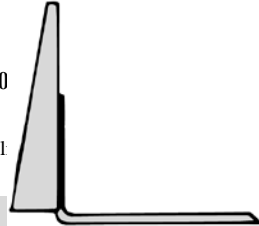

Part Number	Planer Description	SLP in US\$	Discount Percent	Price
-------------	--------------------	-------------	------------------	-------

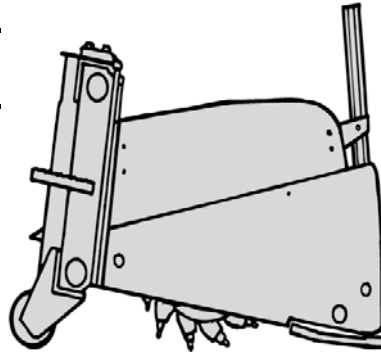

(S450, S510, S550, S530, S570, S590, S595, S630, S650, S740, S750, S770)

(A770) (T450, T550, T590, T595) (T630, T650, T740, T750, T770)

M7019

**14" Planer, Standard Flow**

(Includes manual depth adjust, hydraulic sideshift, and hoses) Must also order a drum.

(No Attachment Control Kit is required)

\$ 8,852.60 24.0% \$6,727.98

**Drums for 14" Planers - MUST order one of the following drum options**

M7019-R01-C03

**14" All Purpose Drum**

\$ 2,445.10 24.0% \$1,858.28

(With 46 bits) (Ship Weight 260 lbs.)

**(S550H, S570H, S590H, S595H)**

**(S630H, S650H, S740H, S750H, S770H, S850H) (A770H)**

**(T550H, T590H, T595H) (T630H, T650H, T740H, T750H, T770H, T870H)**

<b>M7018</b>	<b>18" Planer, High Flow</b> (Includes hydraulic depth adjust, hydraulic sideshift, and hoses) (Must also order drum) (Loader must be equipped with an Attachment Control Kit) (When used on loaders equipped with a 14-Pin Attachment Control Kit , a 14-Pin Attachment T-Harness Kit P/N 7164095 is required)	\$	13,091.80	24.0%	\$9,949.77
--------------	---	----	-----------	-------	------------

**Drums for 18" Planers - MUST order one of the following drum options**

<b>M7018-R01-C10</b>	<b>18" Fast Cut All Purpose Drum</b> (With 47 bits) (Ship Weight 285 lbs.)	\$	3,106.36	24.0%	\$2,360.83
<b>M7018-R01-C11</b>	<b>18" Smooth Cut All Purpose Drum</b> (With 84 bits) (Ship Weight 340 lbs.)	\$	3,962.40	24.0%	\$3,011.42

**(S570H, S590H, S595H, S630H, S650H, S740H, S750H, S770H, S850H)**

**(A770H) (T550H, T590H, T595H, T630H, T650H, T740H, T750H, T770H, T870H)**

<b>M7017</b>	<b>24" Planer, High Flow</b> (Includes hydraulic depth adjust, hydraulic sideshift, and hoses) (Must also order drum) (Loader must be equipped with an Attachment Control Kit) (When used on loaders equipped with a 14-Pin Attachment Control Kit , a 14-Pin Attachment T-Harness Kit P/N 7164095 is required)	\$	15,854.72	24.0%	\$12,049.59
--------------	---	----	-----------	-------	-------------

**Drums for 24" Planers - MUST order one of the following drum options**

<b>M7017-R01-C04</b>	<b>24" Fast Cut All Purpose Drum</b> (With 57 bits) (Ship Weight 375 lbs.)	\$	4,208.45	24.0%	\$3,198.42
<b>M7017-R01-C12</b>	<b>24" Smooth Cut All Purpose Drum</b> (With 124 bits) (Ship Weight 420 lbs.)	\$	5,284.91	24.0%	\$4,016.53

**(S630H, S650H, S740H, S750H, S770H, S850H) (A770H)**

**(T630H, T650H, T740H, T750H, T770H, T870H)**

<b>6726632</b>	<b>40" Planer, High Flow</b> (Includes hydraulic depth adjust, 40" drum, hydraulic sideshift, hydraulic oscillation & hoses) (Loader must be equipped with an Attachment Control Kit) (When used on loaders equipped with a 14-Pin Attachment Control Kit, a 14-Pin Attachment T-Harness Kit is required)	\$	26,409.15	24.0%	\$20,070.96
----------------	---	----	-----------	-------	-------------

\*Other Drum Options available as dealer installed drums - Call for Pricing

Part Number	Rock Bucket Description	SLP in US\$	Discount Percent	Price
-------------	-------------------------	-------------	------------------	-------

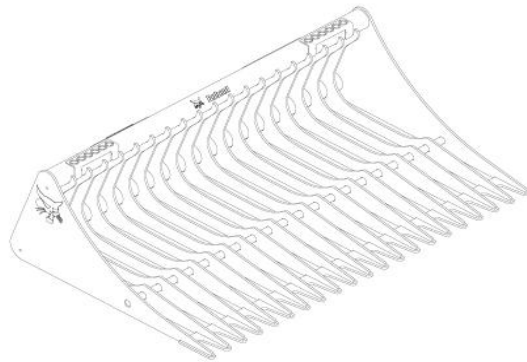

(S450, S510, S550, S530,  
S570, S590, S595, S630,  
S650) (A300)  
(T450 T550, T590, T595)  
(T630, T650)

7185941	62" Rock Bucket	\$ 1,363.52	24.0%	\$1,036.27
---------	-----------------	-------------	-------	------------

(S450, S510, S550, S530,  
T450, T550, T590, T595,  
T630, T650)

7185943	68" Rock Bucket	\$ 1,486.54	24.0%	\$1,129.77
---------	-----------------	-------------	-------	------------

(S630, S650, S740, S750,  
S770, S850) (A770)

(T630, T650, T740, T750,

7185945	74" Rock Bucket	\$ 1,548.05	24.0%	\$1,176.52
---------	-----------------	-------------	-------	------------





Part Number	Seeder Description	SLP in US\$	Discount Percent	Price
-------------	--------------------	-------------	------------------	-------

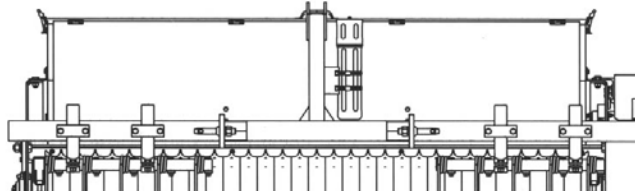



**(S450, S510, S550, S530, S570, S590, S595, S630, S650, S740, S750, S770)**

**(A770) (T450, T550, T590, T595) (T630, T650, T740, T750, T770)**

<b>7167712</b>	<b>Seeder, 72", 3PT Mounting</b> (Must also order Bob-Tach adapter)	\$	6,889.34	24.0%	<b>\$5,235.90</b>
----------------	--	----	----------	-------	-------------------

<b>Part Number</b>	<b>Factory Installed Options Description</b>	<b>SLP in US\$</b>	<b>Discount Percent</b>	<b>Price</b>
--------------------	--	--------------------	-------------------------	--------------

<b>7167758</b>	<b>Bob-Tach Adapter</b> (Allows Seeder to mount on Bob-Tach equipped machines)	\$	681.76	24.0%	<b>\$518.14</b>
----------------	---	----	--------	-------	-----------------

<b>Part Number</b>	<b>Silt Fence Installer Description</b>	<b>SLP in US\$</b>	<b>Discount Percent</b>	<b>Price</b>
--------------------	---	--------------------	-------------------------	--------------

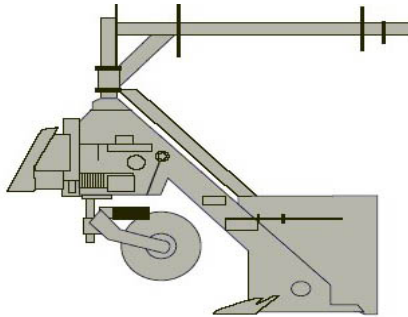

**(S630, S650, S740, S750, S770, S850) (A770)**

**(T550, T590, T595, T630, T650, T740, T750, T770, T870)**

<b>7137320</b>	<b>Silt Fence Installer</b> (Must also order mounting frame)	\$	4,859.45	24.0%	<b>\$3,693.18</b>
----------------	---	----	----------	-------	-------------------

<b>Part Number</b>	<b>Factory Installed Options Description</b>	<b>SLP in US\$</b>	<b>Discount Percent</b>	<b>Price</b>
--------------------	--	--------------------	-------------------------	--------------

<b>7137333</b>	<b>Loader Rigid Mounting Frame</b>	\$	1,189.23	24.0%	<b>\$903.82</b>
----------------	------------------------------------	----	----------	-------	-----------------

<b>7139171</b>	<b>3-Point Rigid Mounting Frame</b> (Must also order Adapter p/n 7137334)	\$	1,168.73	24.0%	<b>\$888.23</b>
----------------	--	----	----------	-------	-----------------

7137332

3-Point Mounting Frame, 72" Side-Shift

\$ 2,327.20 24.0% \$1,768.68

7137331 (Must also order Adapter p/n 7137334) **3-Point Mounting Frame, 84" Side-Shift** \$ 2,455.35 24.0% \$1,866.07

(Must also order Adapter p/n 7137334)

Part Number	Snow Blade Description	SLP in US\$	Discount Percent	Price
-------------	------------------------	-------------	------------------	-------

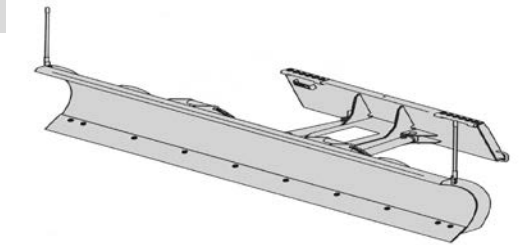

(S70)  
7196165 **54" Utility Blade (with hydraulic angle)** \$ 1,414.78 24.0% \$1,075.23  
(To be used as either a Snow Blade or a Dozer Blade)

(S450, S510, S550, S530, S570, S590, S595) (T450)  
6906107 **60" Snow Blade (with hydraulic angle)** \$ 2,050.40 24.0% \$1,558.30

(S450, S510, S550, S530, S570, S590, S595, S630, S650) (T450)

6905156 **72" Snow Blade (with hydraulic angle)** \$ 2,214.43 24.0% \$1,682.97

(S450, S510, S550, S530, S570, S590, S595) (S630, S650, S740, S750, S770) (T450) (A770)  
6716836 **84" Snow Blade (with hydraulic angle)** \$ 2,414.35 24.0% \$1,834.90

(S630, S650, S740, S750, S770) (A770) (T450)  
6716838 **96" Snow Blade (with hydraulic angle)** \$ 2,511.74 24.0% \$1,908.92

(S510, S550, S530, S570, S590, S595 (S630, S650) (T450, T550, T590) (T630, T650)

7207861	86" Snow Blade – Heavy Duty (with hydraulic angle)	\$	3,808.62	24.0%	\$2,894.55
---------	--	----	----------	-------	------------

(S510, S550, S530, S570, S590, S595, S630, S650, S740, S750, S770)

(A770) (T450, T550, T590, T595) (T630, T650, T740, T750, T770)

7207862	96" Snow Blade – Heavy Duty (with hydraulic angle)	\$	3,904.99	24.0%	\$2,967.79
---------	--	----	----------	-------	------------

(S510, S550, S530, S570, S590, S595, S630, S650, S740, S750, S770, S850)

(A770) (T550, T590, T595, T630, T650, T740, T750, T770, T870)

7207863	108" Snow Blade – Heavy Duty (with hydraulic angle)	\$	4,273.03	24.0%	\$3,247.51
---------	---	----	----------	-------	------------

Part Number	Snow Pusher Description	SLP in US\$	Discount Percent	Price
-------------	-------------------------	-------------	------------------	-------

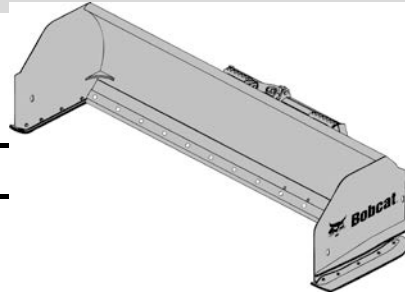

(S450, S510, S550, S530, S570, S590, S595, S630, S650, S740, S750, S770, S850)

(A770) (T450, T550, T590, T595) (T630, T650, T740, T750, T770, T870)

7113767	Snow Pusher, 8'	\$	3,172.99	24.0%	\$2,411.48
---------	-----------------	----	----------	-------	------------

(S590, S595, S630, S650, S740, S750, S770, S850) (A770)

(T550, T590, T595) (T630, T650, T740, T750, T770, T870)

7116164	Snow Pusher, 10'	\$	3,490.81	24.0%	\$2,653.01
---------	------------------	----	----------	-------	------------

Part Number	Snow V-Blade Description	SLP in US\$	Discount Percent	Price
-------------	--------------------------	-------------	------------------	-------

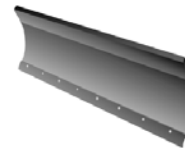
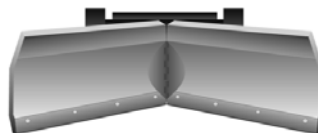

*Blade in "V" Configuration*

*Blade in "Scoop" Configuration*

*Blade in "Angled" Configuration*

**(S450, S510, S550, S530, S570, S590, S595) (T450)**

<b>7104861</b>	<b>60" Snow V-Blade, 7-Pin</b> (Loader must be equipped with an Attachment Control Kit) Blade is equipped with fingertip 7-Pin Control. Adjustable blade width from 53-60 inches.	\$	3,993.15	24.0%	<b>\$3,034.80</b>
----------------	---	----	----------	-------	-------------------

**(S450, S510, S550, S530, S570, S590, S595) (T450, T550, T590, T595)**

<b>6958576</b>	<b>72" Snow V-Blade</b> (Loader must be equipped with an Attachment Control Kit) (When used on loaders equipped with a 14-Pin Attachment Control Kit a 14-Pin Attachment T-Harness Kit (P/N 6725383) is required)	\$	4,264.83	24.0%	<b>\$3,241.27</b>
----------------	--	----	----------	-------	-------------------

**(S450, S510, S550, S530, S570, S590, S595, S630, S650, S740, S750, S770)**

**(A770) (T450, T550, T590, T595) (T630, T650, T740, T750, T770)**

<b>6958577</b>	<b>84" Snow V-Blade</b> (Loader must be equipped with an Attachment Control Kit) (When used on loaders equipped with a 14-Pin Attachment Control Kit a 14-Pin Attachment T-Harness Kit (P/N 6725383) is required)	\$	4,362.23	24.0%	<b>\$3,315.29</b>
----------------	--	----	----------	-------	-------------------

**(S530, S570, S590, S595) (S630, S650, S740, S750, S770) (A770)**

**(T550, T590, T595) (T630, T650, T740, T750, T770)**

<b>6958578</b>	<b>96" Snow V-Blade</b> (Loader must be equipped with an Attachment Control Kit) (When used on loaders equipped with a 14-Pin Attachment Control Kit a 14-Pin Attachment T-Harness Kit (P/N 6725383) is required)	\$	4,459.62	24.0%	<b>\$3,389.31</b>
----------------	--	----	----------	-------	-------------------

**(S630, S650, S740, S750, S770) (A770)**

**(T630, T650, T740, T750, T770)**

<b>6958579</b>	<b>108" Snow V-Blade</b> (Loader must be equipped with an Attachment Control Kit) (When used on loaders equipped with a 14-Pin Attachment Control Kit a 14-Pin Attachment T-Harness Kit (P/N 6725383) is required)	\$	4,557.01	24.0%	<b>\$3,463.33</b>
----------------	---	----	----------	-------	-------------------

Part Number	Snowblower Description	SLP in US\$	Discount Percent	Price
-------------	------------------------	-------------	------------------	-------

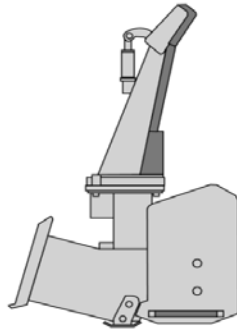

Part Number	SB150 Snowblower Description	SLP in US\$	Discount Percent	Price
-------------	------------------------------	-------------	------------------	-------

(S70)

M7007	<b>SB150 x 36"</b> (Loader must be equipped with a Bobcat 14-Pin Attachment Control Kit)	\$ 4,490.38	24.0%	<b>\$3,412.69</b>
-------	---	-------------	-------	-------------------

(Snowblower includes hydraulic motor package)

(S70) M7008	<b>SB150 x 48"</b> (Loader must be equipped with a Bobcat 14-Pin Attachment Control Kit)	\$ 4,639.03	24.0%	<b>\$3,525.66</b>
----------------	---	-------------	-------	-------------------

(Snowblower includes hydraulic motor package)

Part Number	SB200 Snowblower Description	SLP in US\$	Discount Percent	Price
-------------	------------------------------	-------------	------------------	-------

**Preferred Hydraulic Motor Package (BOLD)**  
*Must order a hydraulic motor package with the SB200 & SB240 Snowblowers*  
*Loader must be equipped with a 7-pin Attachment Control Kit*

(S450*, S510*, S550*, S550H*, S530*, S570*, S570H*, S595*, S595H*) (T450) M7001	<b>SB200 x 60" Snowblower</b>	\$ 4,403.23	24.0%	<b>\$3,346.46</b>
--	-------------------------------	-------------	-------	-------------------

M7001-R01-C01	5.5 Hydraulic Motor Package <b>(S450, S510*, S550*, S530*, S570*, S595*) (T450)</b>	\$ 1,091.84	24.0%	<b>\$829.80</b>
---------------	--	-------------	-------	-----------------

M7001-R01-C02	6.2 Hydraulic Motor Package <b>(S450, S510*, S550*, S530*, S570*, S595*) (T450)</b>	\$ 1,091.84	24.0%	<b>\$829.80</b>
---------------	--	-------------	-------	-----------------

M7001-R01-C04	9.6 Hydraulic Motor Package (S550H*, S570H*, S595H*)	\$	1,219.99	24.0%	\$927.19
 (S450, S510, S550, S550H, S530, S570, S570H, S590, S590H, S595, S595H) (S630*, S630H*, S650*, S650H*, S740*, S750*, S770*) (T450, T550, T550H, T590, T590H, T595, T595H)					
<b>M7002</b>	<b>SB200 x 66" Snowblower</b>	\$	4,541.64	24.0%	\$3,451.64
M7002-R01-C01	5.5 Hydraulic Motor Package (S450, S510, S550, S530, S570, S590, S595) (T450, T550, T590, T595)	\$	1,091.84	24.0%	\$829.80
M7002-R01-C02	6.2 Hydraulic Motor Package (S450, S510, S550, S530, S570, S590, S595) (T450, T550, T590, T595)	\$	1,091.84	24.0%	\$829.80
M7002-R01-C03	8.0 Hydraulic Motor Package (S630*, S650*, S740*, S750*, S770*) (S550H, S570H, S590H, S595) (T550H, T590H, T595H)	\$	1,153.35	24.0%	\$876.55
M7002-R01-C04	9.6 Hydraulic Motor Package (S550H, S570H, S590H, S595H, S630H*, S650H*) (T550H, T590H, T595H)	\$	1,219.99	24.0%	\$927.19

**\*Offset rims required**

*Must order a hydraulic motor package with the SB200 Snowblowers  
Loader must be equipped with a 7-pin Attachment Control Kit*

 (S450, S510, S550, S550H, S530, S570, S570H, S590, S590H, S595, S595H) (S630, S630H, S650, S650H, S740, S750, S770) (A770) (T450, T550, T550H, T590, T590H, T595, T595H) (T630, T630H, T650, T650H, T740*, T750*, T770*)					
<b>M7003</b>	<b>SB200 x 72" Snowblower</b>	\$	4,690.29	24.0%	\$3,564.62
M7003-R01-C01	5.5 Hydraulic Motor Package (S450, S510, S550, S530, S570, S590) (T450, T550, T590, T595)	\$	1,091.84	24.0%	\$829.80
M7003-R01-C02	6.2 Hydraulic Motor Package (S450, S510, S550, S530, S570, S590, S250, S300, S330) (T450, T550, T590, T595)	\$	1,091.84	24.0%	\$829.80
M7003-R01-C03	8.0 Hydraulic Motor Package (S630, S650, S740, S750, S770) (A770) (T630, T650, T740*, T750*, T770*) (S550H, S570H, S590H) (T550H, T590H, T595H)	\$	1,153.35	24.0%	\$876.55
M7003-R01-C04	9.6 Hydraulic Motor Package (S550H, S570H, S590H, S630H, S650H) (T550H, T590H, , T595H, T630H, T650H)	\$	1,219.99	24.0%	\$927.19

(S510, S550, S550H, S530, S570, S570H, S590, S590H, S595, S595H)



(S630, S630H, S650, S650H, S740, S750, S770, S850) (A770)  
 (T550, T550H, T590, T590H, T595, T595H) (T630, T630H, T650, T650H, T740, T750, T770)

<b>M7004</b>	<b>SB200 x 78" Snowblower</b>	\$	4,972.22	24.0%	<b>\$3,778.89</b>
--------------	-------------------------------	----	----------	-------	-------------------

M7004-R01-C02	6.2 Hydraulic Motor Package	\$	1,091.84	24.0%	<b>\$829.80</b>
---------------	-----------------------------	----	----------	-------	-----------------

(S510, S550, S530, S570, S590, S595)  
 (T550, T590, T595)

M7004-R01-C03	8.0 Hydraulic Motor Package	\$	1,153.35	24.0%	<b>\$876.55</b>
---------------	-----------------------------	----	----------	-------	-----------------

(S630, S650, S740, S750, S770, S850) (A770) (T630, T650, T740, T750, T770)  
 (S550H, S570H, S590H) (T550H, T590H, T595)

M7004-R01-C04	9.6 Hydraulic Motor Package	\$	1,219.99	24.0%	<b>\$927.19</b>
---------------	-----------------------------	----	----------	-------	-----------------

(S550H, S570H, S590H, S630H, S650H) (T550H, T590H, T630H, T650H)

*Must order a hydraulic motor package with the SB240 Snowblowers & 7 pin attachment control*

Part Number	Description	SLP in US\$	Discount Percent	Price
-------------	-------------	-------------	------------------	-------

(S550H, S570H, S590H, S595H) (S630H, S650H, S740, S750, S770) (A770) (T550H, T590H, T595H)  
 (T630H, T650H, T740\*, T750\*, T770\*)

<b>M7005</b>	<b>SB240 x 72" Snowblower</b>	\$	6,274.22	24.0%	<b>\$4,768.41</b>
--------------	-------------------------------	----	----------	-------	-------------------

M7005-R01-C03	8.0 Hydraulic Motor Package	\$	1,153.35	24.0%	<b>\$876.55</b>
---------------	-----------------------------	----	----------	-------	-----------------

(S750, S770) (A770) (T740\*, T750\*, T770\*)  
 (S550H, S570H, S590H, S595H) (T550H, T590H, T595H)

M7005-R01-C04	9.6 Hydraulic Motor Package	\$	1,219.99	24.0%	<b>\$927.19</b>
---------------	-----------------------------	----	----------	-------	-----------------

(S550H, S570H, S590H, S595H, S630H, S650H) (T550H, T590H, T595H, T630H, T650H)

**\* Narrow Track Option Required**

*Must order a hydraulic motor package with the SB240 Snowblowers & 7 pin attachment control*

(S630H, S650H, S740, S750, S770, S850) (A770) (T550H, T590H) (T630H, T650H, T740, T750, T770, T870)

<b>M7006</b>	<b>SB240 x 84" Snowblower</b>	\$	6,407.50	24.0%	<b>\$4,869.70</b>
--------------	-------------------------------	----	----------	-------	-------------------

M7006-R01-C03	8.0 Hydraulic Motor Package	\$	1,153.35	24.0%	<b>\$876.55</b>
---------------	-----------------------------	----	----------	-------	-----------------

(S740, S750, S770) (A770) (T740, T750\*, T770\*)

M7006-R01-C04	9.6 Hydraulic Motor Package	\$	1,219.99	24.0%	<b>\$927.19</b>
---------------	-----------------------------	----	----------	-------	-----------------

(S630H, S650H) (T550H, T590H, T630H, T650H)

Part Number	Description	SLP in US\$	Discount Percent	Price
-------------	-------------	-------------	------------------	-------



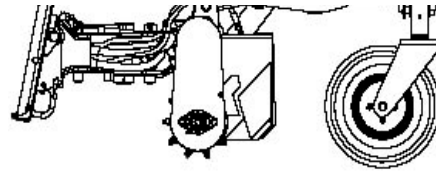

(S70)  
 6958310                      48" Soil Conditioner, Manual Angle                      \$      6,253.72      24.0%      \$4,752.83

(S450, S510, S550, S550H, S530, S570, S570H, S590, S590H, S595, S595H )  
 (S630, S630H, S650, S650H, S740, S750, S750H, S770, S770H)  
 (A770, A770H) (T450, T550, T550H, T590, T590H, T595H) (T630, T630H, T650, T650H)  
 6906513                      72" Soil Conditioner, Manual Angle

\$      8,201.60      24.0%      \$6,233.22

7135945	72" Soil Conditioner, Hydraulic Angle and Depth (Loader must be equipped with an Attachment Control Kit)	\$      8,908.99	24.0%	\$6,770.83
---------	---	------------------	-------	------------

(S550H, S570H, S590H, S595, S595H, S630H, S650H, S740H, S750H, S770H)  
 (A770H) (T550H, T590H, T595H)  
 (T630H, T650H, T740H, T750H, T770H)  
 7135944                      72" Soil Conditioner, High Flow Hydraulic Angle and Depth  
 (Loader must be equipped with an Attachment Control Kit)

\$      9,216.55      24.0%      \$7,004.58

(S530, S570, S570H, S590, S590H, S595, S595H)  
 (S630, S630H, S650, S650H, S740, S750, S750H, S770, S770H, S850)  
 (A770, A770H) (T550, T550H, T590, T590H, T595H)  
 (T630, T630H, T650, T650H, T750, T740H, T750H, T770, T770H, T870)  
 7135946                      84" Soil Conditioner, Hydraulic Angle and depth  
 (Loader must be equipped with an Attachment Control Kit)

\$      9,421.59      24.0%      \$7,160.41

(S630H, S650H, S740H, S750H, S770H, S850H)  
 (A770H) (T630H, T650H, T750H, T770H, T870H)  
 7135947                      84" Soil Conditioner, High Flow Hydraulic Angle and Depth  
 (Loader must be equipped with an Attachment Control Kit)

\$      9,831.67      24.0%      \$7,472.07

Part	Spreader	SLP in US\$	Discount	Price
------	----------	-------------	----------	-------

Number	Description	Percent
--------	-------------	---------

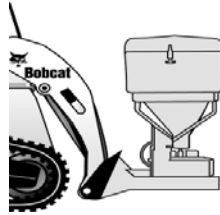

(S450, S510, S550, S530, S570, S590, S595)  
(S630, S650, S740, S750, S770, S850) (A770)

(T450, T550, T590, T595) (T630, T650, T750, T770, T870)

7157284	HS8 Spreader	\$	3,439.55	24.0%	\$2,614.05
---------	--------------	----	----------	-------	------------

--	--	--	--	--	--

Part Number	Steel Tracks Description	SLP in US\$	Discount Percent	Price
-------------	--------------------------	-------------	------------------	-------



--	--	--	--	--	--

**Complete Track Package**

*Each part number includes a set of tracks, web binder, hardware, and if required, wheel spacers and lift arm stops.*

(S510, S530, S550, S570, S590, S595)

7222581	10.00-16.5 (72" loader width)	\$	3,296.02	24.0%	\$2,504.97
---------	-------------------------------	----	----------	-------	------------

(Order PN 7233132 if loader is equipped with 31-12-16.5 tires)

(S590, S595)

7233132	31-12-16.5 (76" loader width)	\$	2,967.95	24.0%	\$2,255.65
---------	-------------------------------	----	----------	-------	------------

(Order PN 7222581 if loader is equipped with 10-16.5 tires)

(S630, S650)

7178955	12.00-16.5 (79" loader width)	\$	3,393.41	24.0%	\$2,578.99
---------	-------------------------------	----	----------	-------	------------

(S740, S750, S770)

7191754	12.00-16.5 (79" loader width)	\$	4,203.32	24.0%	\$3,194.52
---------	-------------------------------	----	----------	-------	------------

(S850)

7191757	14.00-17.5 (86" loader width)	\$	4,864.57	24.0%	\$3,697.08
---------	-------------------------------	----	----------	-------	------------

**Note on use of poly fill tires with steel tracks - Only pneumatic tires with Superflex formula poly fill manufactured by Arnco are permitted for use inside steel tracks. Bobcat factory poly-filled tires meet this requirement. All other tires are considered non-approved. The use of non-approved tires will void the loader and track warranties.**

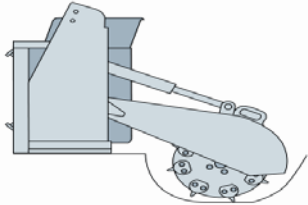
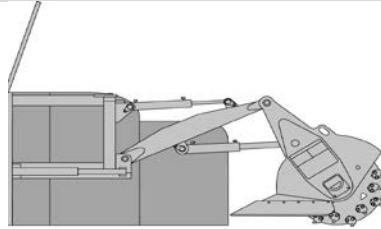
Part Number	Stump Grinder Description	SLP in US\$	Discount Percent	Price
	 <p><i>SG30 Stump Grinder</i></p>			
(S70) 7100641	<p><b>SG30 Stump Grinder</b> (Loader must be equipped with a 14-Pin Attachment Control Kit)</p>	\$ 5,120.87	24.0%	\$3,891.86
	 <p><i>SG60 and SGX60 Stump Grinder</i></p>			
(S550H, S530, S530H, S570, S570H, S590, S590H, S595, S595H) (S630, S630H, S650, S650H, S740, S740H, S750, S770, S850) (A770) (T550, T550H, T590, T590H, T595, T595H, T630, T630H, T650, T650H, T740, T750, T770, T870) 6808034	<p><b>SG60 Stump Grinder</b> <b>*Not approved for use with 37 GPM High Flow Loaders</b> (Loader must be equipped with an Attachment Control Kit) (When used on loaders equipped with a 14-Pin Attachment Control Kit, a 14-Pin Attachment T Harness Kit is required)</p>	\$ 8,806.47	24.0%	\$6,692.92
(S530H, S570H, S595H) (S630H, S650H, S740H, S750H, S770H, S850H) (A770H) (T550H, T590H, T595H, T630H, T650H, T740H, T750H, T770H, T870H) 7112201	<p><b>SGX60 Stump Grinder</b> (Loader must be equipped with an Attachment Control Kit) (When used on loaders equipped with a 14-Pin Attachment Control Kit, a 14-Pin Attachment T-Harness is required)</p>	\$ 9,114.03	24.0%	\$6,926.66

Part Number	Sweeper Description	SLP in US\$	Discount Percent	Price
-------------	---------------------	-------------	------------------	-------

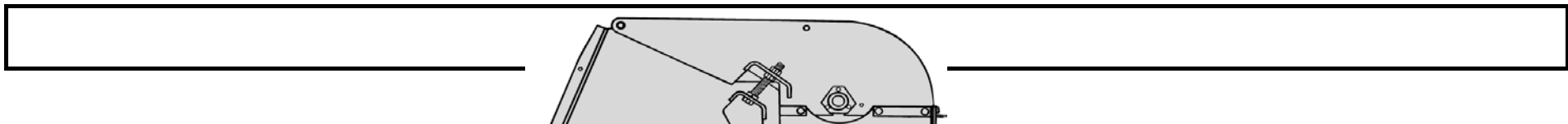





(S70)				
7196028	40" Rotary Tiller	\$	4,136.68	24.0% \$3,143.88

(S450, S510, S550, S550H, S530, S530H, S570, S570H, S590, S590H, S595, S595H)  
 (S630, S630H, S650, S650H, S740, S750, S750H, S770, S770H)  
 (T450, T550, T550H, T590, T590H, T595, T595H) (T630, T630H, T650, T650H)

7104371	62" Rotary Tiller	\$	4,756.93	24.0% \$3,615.27
---------	-------------------	----	----------	------------------

(S550, S550H, S530, S530H, S570, S570H, S590, S590H, S595H)  
 (S630, S630H, S650, S650H, S740, S740H, S750, S750H, S770, S770H)  
 (A770, A770H) (T630, T630H, T650, T650H, T740, T740H, T750, T750H, T770, T770H)  
 (T550, T550H, T590, T590H, T595H)

7102125	76" Rotary Tiller	\$	5,782.13	24.0% \$4,394.42
---------	-------------------	----	----------	------------------

Part Number	Tilt Tach Description	SLP in US\$	Discount Percent	Price
-------------	-----------------------	-------------	------------------	-------

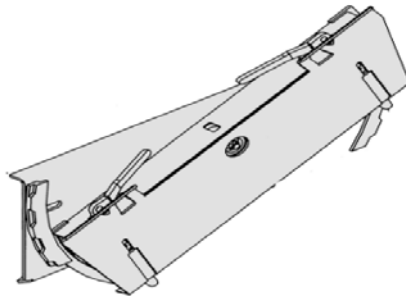

(S450, S510, S550, S530, S570, S590, S595) (S630, S650) (T450, T550, T590, T595)				
7101600	Tilt-Tatch	\$	2,388.72	24.0% \$1,815.42

(Interface between the Loader's Bob-Tach and non hydraulic attachments)

Manual for New Load Ratings.  
 Tilt-Tatch can be used with non-hydraulic attachments only.



Part Number	Tree Spade Description	SLP in US\$	Discount Percent	Price
-------------	------------------------	-------------	------------------	-------

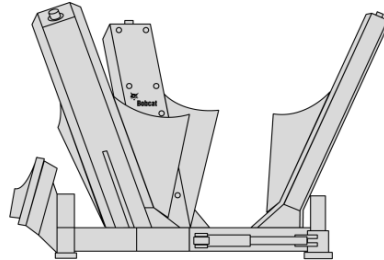

**ACD Tree Spades**

Tree Spades are designed for fingertip spade control on G-Series and newer loaders only. The switches located on the loader's steering lever control Tree Spades. Loaders must be equipped with a 7-Pin control Kit

**(S510, S550, S530, S570, S590, S595, S630, S650, S740, S750, S770, S850) (A770)**

**(T550, T590, T595) (T630, T650, T740, T750, T770, T870)**

<b>7149485</b>	<b>32" Convertible Tree Spade, Cone</b> (Must also order Pendant Control Kit or 7-Pin ACD Conversion Kit)	\$ 11,082.41	<b>24.0%</b>	<b>\$8,422.63</b>
----------------	--	--------------	--------------	-------------------

<b>7149442</b>	<b>32" Convertible Tree Spade, Modified</b> (Must also order Pendant Control Kit or 7-Pin ACD Conversion Kit)	\$ 11,082.41	<b>24.0%</b>	<b>\$8,422.63</b>
----------------	--	--------------	--------------	-------------------

**(S510, S550, S530, S570, S590, S595, S630, S650, S740, S750, S770, S850) (A770)**

**(T550, T590, T595) (T630, T650, T740, T750, T770, T870)**

<b>7149488</b>	<b>36" Convertible Tree Spade, Cone</b> (Must also order Pendant Control Kit or 7-Pin ACD Conversion Kit)	\$ 11,718.04	<b>24.0%</b>	<b>\$8,905.71</b>
----------------	--	--------------	--------------	-------------------

<b>7149445</b>	<b>36" Convertible Tree Spade, Modified</b> (Must also order Pendant Control Kit or 7-Pin ACD Conversion Kit)	\$ 11,718.04	<b>24.0%</b>	<b>\$8,905.71</b>
----------------	--	--------------	--------------	-------------------

**(S740, S750, S770, S850) (A770)**

**(T740, T750, T770, T870)**

<b>7149491</b>	<b>44" Convertible Tree Spade, Cone</b> (Must also order Pendant Control Kit p/n 7152664 or 7-Pin ACD Conversion Kit)	\$ 16,008.50	<b>24.0%</b>	<b>\$12,166.46</b>
----------------	--	--------------	--------------	--------------------

<b>7149306</b>	<b>44" Convertible Tree Spade, Modified</b> (Must also order Pendant Control Kit p/n 7152664 or 7-Pin ACD Conversion Kit)	\$ 15,916.23	<b>24.0%</b>	<b>\$12,096.33</b>
----------------	--	--------------	--------------	--------------------

**Note: Rear Stabilizers are required and counterweights are recommended when using the tree spade**

Part Number	Accessories Description	SLP in US\$	Discount Percent	Price
7152662	(All Loader Series) <b>ACD Conversion Kit, 7-Pin</b> (Price includes \$90 for installation)	\$ 276.80	24.0%	\$210.37
7152663	<b>Pendant Control Kit, 3-Blade</b> (For 24" through 36" Convertible Tree Spades) (No additional Control Kits needed.) (Price includes \$90 for installation)	\$ 492.10	24.0%	\$373.99
7152664	<b>Pendant Control Kit, 4-Blade</b> (For 44" Convertible Tree Spades) (No additional Control Kits needed.) (Will operate 4-Blade convertible Tree Spades) (Price includes \$90 for installation)	\$ 553.61	24.0%	\$420.74

Part Number	Trench Compactor Description	SLP in US\$	Discount Percent	Price
-------------	------------------------------	-------------	------------------	-------



(S510, S550, S530, S570, S590, S595) (A770)

(S630, S650, S740, S750, S770)

(T450, T550, T590, T505, T630, T650, T740, T750, T770)

6905277	<b>Trench Compactor</b> (Comes standard with a 4 1/2" Pad and compacts trenches up to 8" wide) (Wheel-type vibratory compactor)	\$ 8,498.91	24.0%	\$6,459.17
---------	---	-------------	-------	------------

Part Number	Trencher Description	SLP in US\$	Discount Percent	Price
-------------	----------------------	-------------	------------------	-------

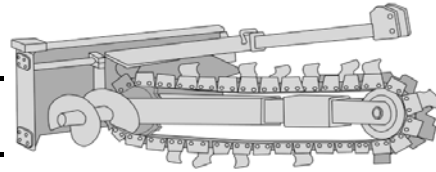

Part Number	LT112 Trencher Description	SLP in US\$	Discount Percent	Price
(S70) M7011	<b>LT112 Trencher</b> (Includes mounting frame, hoses, couplers, 2' depth, manual sideshift, 4" trench cleaner) (Can only order one factory installed chain option per trencher model)	\$ 3,552.32	24.0%	\$2,699.76

*2' Chain Options are 1.654" Double Standard (DS) Anti-Back Flex (ABF)*

M7011-R01-C02	2' x 4" cup teeth, Single Standard pattern	\$ 466.47	24.0%	\$354.51
M7011-R01-C01	2' x 4" Cup Teeth, Double Standard Pattern	\$ 568.99	24.0%	\$432.43
M7011-R01-C03	2' x 4" cup & carbide teeth, Double Standard pattern	\$ 1,040.58	24.0%	\$790.84
M7011-R01-C05	2' x 4" Shark/Cup teeth, Double Standard pattern	\$ 692.01	24.0%	\$525.93
M7011-R01-C06	2' x 6" Shark/Cup teeth, Double Standard pattern	\$ 871.42	24.0%	\$662.28

Part Number	LT113 Trencher Description	SLP in US\$	Discount Percent	Price
(S70) M7014	<b>LT113 Trencher</b> (Includes mounting frame, hoses, couplers, 3' depth, manual sideshift, 4" trench cleaner) (Can only order one factory installed chain option per trencher model)	\$ 3,777.86	24.0%	\$2,871.18

*3' Chain Options are 1.654" Double Standard (DS) Anti-Back Flex (ABF)*

M7014-R01-C02	3' x 4" Cup Teeth, Single Standard Pattern	\$ 451.09	24.0%	\$342.83
M7014-R01-C04	3' x 6" Cup Teeth, Single Standard Pattern	\$ 481.84	24.0%	\$366.20
M7014-R01-C01	3' x 4" Cup Teeth, Double Standard Pattern	\$ 512.60	24.0%	\$389.58
M7014-R01-C03	3' x 4" Cup & Carbide Teeth, Double Standard Pattern	\$ 1,050.83	24.0%	\$798.63
M7014-R01-C06	3' x 4" Shark/Cup Teeth, Double Standard Pattern	\$ 845.79	24.0%	\$642.80
M7014-R01-C07	3' x 6" Shark/Cup Teeth, Double Standard Pattern	\$ 1,055.96	24.0%	\$802.53

Part	LT213 Trencher	SLP in US\$	Discount	Price
------	----------------	-------------	----------	-------

Number	Description	Percent
--------	-------------	---------

(S450) (T450)

<b>M7013</b>	<b>LT213 Trencher</b> (Includes 3' depth, manual sideshift, and 4" trench cleaner) (Hyd Side Shift is available) (Can only order one factory installed chain option per trencher model)	\$ 3,803.49	<b>24.0%</b>	<b>\$2,890.65</b>
--------------	---	-------------	--------------	-------------------

*Chains are 1.654" Double Standard (DS) Anti-Back Flex (ABF)*

<b>M7013-R01-C02</b>	<b>3' x 4" Cup Teeth, Single Standard Pattern</b>	\$ 451.09	<b>24.0%</b>	<b>\$342.83</b>
<b>M7013-R01-C04</b>	<b>3' x 6" Cup Teeth, Single Standard Pattern</b>	\$ 481.84	<b>24.0%</b>	<b>\$366.20</b>
<b>M7013-R01-C01</b>	<b>3' x 4" Cup Teeth, Double Standard Pattern</b>	\$ 512.60	<b>24.0%</b>	<b>\$389.58</b>
<b>M7013-R01-C03</b>	<b>3' x 4" Cup &amp; Carbide Teeth, Double Standard Pattern</b>	\$ 1,050.83	<b>24.0%</b>	<b>\$798.63</b>
<b>M7013-R01-C06</b>	<b>3' x 4" Shark/Carbide Teeth, Double Standard Pattern</b>	\$ 845.79	<b>24.0%</b>	<b>\$642.80</b>
<b>M7013-R01-C07</b>	<b>3' x 6" Shark/Carbide Teeth, Double Standard Pattern</b>	\$ 984.19	<b>24.0%</b>	<b>\$747.99</b>

7274348	<b>Dealer Installed Hydraulic Side Shift</b>	\$	673.56	24.0%	\$511.90
Can be installed on the LT313 and LT213 trenchers hydraulically side shift the trencher boom 23.1 inches					



Part Number	Description	SLP in US\$	Discount Percent	Price
<b>LT313 Trencher</b>				
(S450, S510, S550, S530, S570, S590, S595) (S630, S650, S740, S750, S770)				
(A770) (T450, T550, T590) (T630, T650)				
M7015	<b>LT313 Trencher</b>	\$ 4,587.77	24.0%	\$3,486.71
(Includes 3' depth, manual sideshift, 6" trench cleaner) (Hyd Side Shift is available)				
(Can only order one factory installed chain option per trencher model)				

*All chains are 2.0" Double Standard (DS) Anti-Back Flex (ABF)*

M7015-R01-C02	3' x 6" Cup Teeth in Single Standard Pattern	\$ 635.62	24.0%	\$483.07
M7015-R01-C05	3' x 8" Cup Teeth in Single Standard Pattern	\$ 671.51	24.0%	\$510.34
M7015-R01-C01	3' x 6" Cup Teeth in Double Standard Pattern	\$ 1,055.96	24.0%	\$802.53
M7015-R01-C04	3' x 6" Shark Tooth/Cup Teeth in Double Standard Pattern	\$ 1,066.21	24.0%	\$810.32
M7015-R01-C03	3' x 6" Cup & Carbide Teeth in Double Standard Pattern	\$ 1,727.46	24.0%	\$1,312.87
M7015-R01-C06	3' x 8" Cup & Carbide Teeth in Double Standard Pattern	\$ 1,768.47	24.0%	\$1,344.04
M7015-R01-C14	3' x 8" Shark Tooth/Cup Teeth in Double Standard Pattern	\$ 1,286.63	24.0%	\$977.84

*The LT313 is assembled as a 4' dig depth when ordering the 4' chain option  
(Boom Guide included with 4' factory installed chain)*

M7015-R01-C08	4' x 6" Cup Teeth in Single Standard Pattern	\$ 784.28	24.0%	\$596.05
M7015-R01-C11	4' x 8" Cup Teeth in Single Standard Pattern	\$ 881.67	24.0%	\$670.07
M7015-R01-C07	4' x 6" Cup Teeth in Double Standard Pattern	\$ 968.81	24.0%	\$736.30
M7015-R01-C10	4' x 6" Shark Tooth/Cup Teeth in Double Standard Pattern	\$ 1,250.74	24.0%	\$950.57
M7015-R01-C09	4' x 6" Cup & Carbide Teeth in Double Standard Pattern	\$ 1,937.63	24.0%	\$1,472.60
M7015-R01-C12	4' x 8" Cup & Carbide Teeth in Double Standard Pattern	\$ 2,070.90	24.0%	\$1,573.89
M7015-R01-C15	4' x 8" Shark Tooth/Cup Teeth in Double Standard Pattern	\$ 1,419.90	24.0%	\$1,079.13



7274348	<b>Dealer Installed Hydraulic Side Shift</b>	\$	673.56	24.0%	\$511.90
Can be installed on the LT313 and LT213 trenchers hydraulically side shift the trencher boom 23.1 inches					

Part Number	LT414 High Flow Trencher Description	SLP in US\$	Discount Percent	Price
(S550H, S530H, S570H, S590H, S595H) (S630H, S650H, S740H, S750H, S770H) (A770H) (T550H, T590H, T595H) (T630H, T650H, T740H, T750H, T770H)	4' Depth			
(S630H, S650H, S740H, S750H, S770H) (A770H) (T630H, T650H, T740H, T750H, T770H)	5' Depth			
<b>M7016</b>	<b>LT414 Trencher (High Flow)</b> (Includes 4' or 5' depth, hydraulic sideshift, and 6" trench cleaner) (Can only order one factory installed chain option per trencher model) (Loader must be equipped with High Flow auxiliary hydraulics)  <i>Chains are 2.0" Single Standard (SS) or Double Standard (DS) Anti-Back Flex (ABF)</i>	\$ 6,843.21	24.0%	\$5,200.84
M7016-R01-C08	4' x 6" Cup Teeth, Single Standard Pattern	\$ 809.91	24.0%	\$615.53
M7016-R01-C07	4' x 6" Cup Teeth, Double Standard Pattern	\$ 932.93	24.0%	\$709.03
M7016-R01-C09	4' x 6" Cup & Carbide Teeth, Double Standard Pattern	\$ 1,937.63	24.0%	\$1,472.60
M7016-R01-C10	4' x 6" Shark Tooth/Cup Teeth in Double Standard Pattern	\$ 1,604.44	24.0%	\$1,219.37
M7016-R01-C11	4' x 8" Cup Teeth, Single Standard Pattern	\$ 861.17	24.0%	\$654.49
M7016-R01-C12	4' x 8" Cup & Carbide Teeth in Double Standard Pattern	\$ 2,014.52	24.0%	\$1,531.03
M7016-R01-C14	4' x 8" Shark/Carbide Teeth in Double Standard Pattern	\$ 1,486.54	24.0%	\$1,129.77
M7016-R01-C04	5' x 6" Cup Teeth, Single Standard Pattern	\$ 963.69	24.0%	\$732.40
<b>M7016-R01-C01</b>	<b>5' x 6" Cup Teeth, Double Standard Pattern</b>	<b>\$ 1,102.09</b>	<b>24.0%</b>	<b>\$837.59</b>
<b>M7016-R01-C03</b>	<b>5' x 6" Cup &amp; Carbide Teeth, Double Standard Pattern</b>	<b>\$ 2,296.45</b>	<b>24.0%</b>	<b>\$1,745.30</b>
M7016-R01-C02	5' x 6" Shark Tooth/Cup Teeth in Double Standard Pattern	\$ 1,829.98	24.0%	\$1,390.79
M7016-R01-C06	5' x 8" Cup Teeth, Single Standard Pattern	\$ 1,020.07	24.0%	\$775.26
M7016-R01-C05	5' x 8" Cup & Carbide Teeth in Double Standard Pattern	\$ 2,511.74	24.0%	\$1,908.92

Part Number	LT405 High Flow Trencher Description	SLP in US\$	Discount Percent	Price
(S530H, S570H, S590H, S595H, S630H, S650H, S740H, S750H, S770H) (A770H) (T550H, T590H, T595H) (T630H, T650H, T740H, T750H, T770H)				
<b>6906100</b>	<b>LT405 Trencher (High Flow)</b> (Includes 3' – 4' adjustable boom setup at 4', double standard ABF chain, Hydraulic	\$ 10,749.22	24.0%	\$8,169.41

Sideshift, 6" trench cleaner, hoses and couplers) **(Must also order teeth)**

Part Number	Vibratory Roller Description	SLP in US\$	Discount Percent	Price
-------------	------------------------------	-------------	------------------	-------

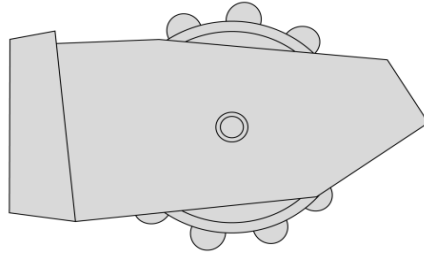

(S450, S510, S550, S530, S570, S590, S595) (T450, T550, T590, T595)

7165403	48" Vibratory Roller with Padded Drum	\$ 8,652.69	24.0%	\$6,576.04
7165404	48" Vibratory Roller with Smooth Drum	\$ 8,442.52	24.0%	\$6,416.32

(S590, S595, S630, S650, S750, S770, S850) (A770)

(T630, T650, T740, T750, T770, T870)

7165401	73" Vibratory Roller with Padded Drum	\$ 9,975.20	24.0%	\$7,581.15
7165402	73" Vibratory Roller with Smooth Drum	\$ 9,708.64	24.0%	\$7,378.57

(S750, S770, S850) (A770)

(T630, T740, T750, T770, T870)

7165400	80" Vibratory Roller with Smooth Drum	\$ 10,451.91	24.0%	\$7,943.45
---------	---------------------------------------	--------------	-------	------------

Part Number	Wheel Saw Description	SLP in US\$	Discount Percent	Price
-------------	-----------------------	-------------	------------------	-------





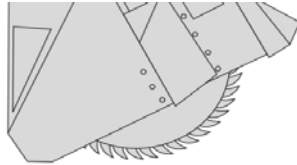

**18" Wheel Saw with 3" Wheel**

(Must order the two part numbers listed below—18" Wheel Saw and 3" Wheel)

(Must also order Attachment Control Kit)

(S590H, S595H, S630H, S650H, S740H, S750H, S770H, S850, S850H) (A770H) (T550H, T590H, T595H)

(T630H, T650H, T740H, T750H, T770H, T870, T870H)

<b>6729537</b>	<b>WS18 Wheel Saw</b>	\$	15,680.43	<b>24.0%</b>	<b>\$11,917.13</b>
<b>6729544</b>	<b>3" Wheel</b>	\$	3,398.54	<b>24.0%</b>	<b>\$2,582.89</b>

(Weight 650 lbs. Wheel Width 3.13")

**Note: There is no Trench Cleaner available with the 3" Wheel.**

**18" Wheel Saw with 6" Wheel and 6" Trench Cleaner**

(Must order the three part numbers listed below—18" Wheel Saw, 6" Wheel and 6" Trench Cleaner)

(Must also order Attachment Control Kit)

(S590H, S595H, S630H, S650H, S740H, S750H, S770H, S850, S850H) (A770H) (T550H, T590H, T595H)

(T630H, T650H, T740H, T750H, T770H, T870, T870H)

<b>6729537</b>	<b>WS18 Wheel Saw</b>	\$	15,680.43	<b>24.0%</b>	<b>\$11,917.13</b>
<b>6729546</b>	<b>6" Wheel</b>	\$	3,398.54	<b>24.0%</b>	<b>\$2,582.89</b>

(Weight 395 lbs., Wheel Width 6.25")

<b>6729550</b>	<b>6" Trench Cleaner</b>	\$	1,266.12	<b>24.0%</b>	<b>\$962.25</b>
----------------	--------------------------	----	----------	--------------	-----------------

(Weight 95 lbs.)



<b>Part Number</b>	<b>Wheel Saw Description</b>	<b>SLP in US\$</b>	<b>Discount Percent</b>	<b>Price</b>
--------------------	------------------------------	--------------------	-------------------------	--------------

**24" Wheel Saw with 6" Wheel and 6" Trench Cleaner**

(Must order the three part numbers listed below—24" Wheel Saw, 6" Wheel and 6" Trench Cleaner)

(Must also order Attachment Control Kit)

(S740H, S750H, S770H, S850, S850H) (A770H)

(T750H, T770H, T870, T870H)

6729566                      WS24 Wheel Saw

\$    18,105.03      24.0%      \$13,759.82

<b>6729573</b>	<b>6" Wheel</b> (Weight 585 lbs., Wheel Width 6.25")	\$ 4,418.61	24.0%	<b>\$3,358.15</b>
<b>6729577</b>	<b>6" Trench Cleaner</b> (Weight 130 lbs.)	\$ 1,450.66	24.0%	<b>\$1,102.50</b>

**24" Wheel Saw with 8" Wheel and 8" Trench Cleaner**

(Must order the three part numbers listed below—24" Wheel Saw, 8" Wheel and 8" Trench Cleaner)

(Must also order Attachment Control Kit)

(S740H, S750H, S770H, S850, S850H) (A770H)

(T750H, T770H, T870, T870H)

<b>6729566</b>	<b>WS24 Wheel Saw</b>	\$ 18,105.03	24.0%	<b>\$13,759.82</b>
<b>6729575</b>	<b>8" Wheel</b> (Weight 618 lbs., Wheel Width 7.88")	\$ 5,126.00	24.0%	<b>\$3,895.76</b>
<b>6729579</b>	<b>8" Trench Cleaner</b> (Weight 148 lbs.)	\$ 1,553.18	24.0%	<b>\$1,180.42</b>



